

ALLIANCE

OUTDOOR LIGHTING

LANDSCAPE & ARCHITECTURAL LIGHTING | 2025
LIST PRICE GUIDE
DESIGNER SERIES

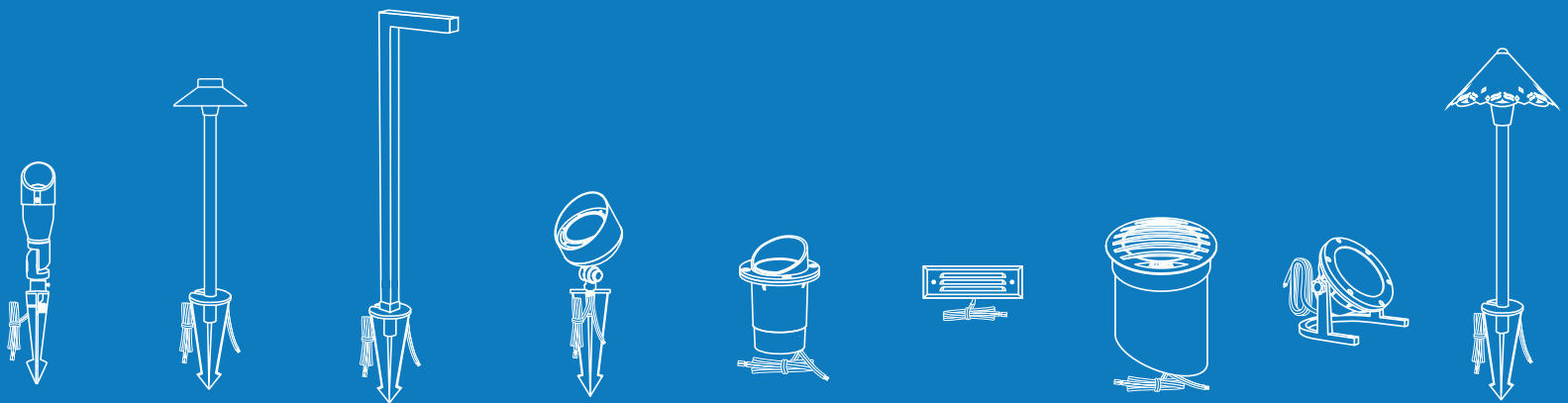

Effective February 1, 2025
Prices and specifications subject to
change without notice.

TABLE OF CONTENTS

Accent / Uplights	4	BOLLARD100	13	GL360	23
BL50	4	Wall Wash	14	GL360-bt	23
BL110	4	FL50	14	GL370	24
HSC-BL1	4	FL50-bt	14	GL370-bt	24
HSC-BL2	4	FL100	14	GL380	24
HSC-BL3-BT	4	FL200	14	GL380-bt	24
BL200	5	FL200-bt	14	GL390	25
BL200-bt	5	Down Lights	15	GL390-bt	25
BL900	6	DL50	15	GL100-TOP	25
BL900-bt	6	DL100	15	GL150-TOP	25
BL300	6	DL200	15	GL160-TOP	25
BL395-LED	6	DL200-bt	15	GL170-TOP	25
BL400-bt	6	HL100	16	GL180-TOP	25
Area & Path	7	HL100-bt	16	GL190-TOP	25
PL300	7	HL200	16	GL300-TOP	26
PL300-bt	7	HL200-bt	16	GL310-TOP	26
PL600-LED	7	In-Ground Lights	17	GL350-TOP	26
AL100	8	WL100	17	GL360-TOP	26
AL150	8	WL200	17	GL370-TOP	26
AL250	8	WL300	17	GL380-TOP	26
AL300	8	CGWL01	18	GL390-TOP	26
AL400	8	CGWL02	18	Hardscape	27
AL500	8	WL400-bt	18	SL100	27
AL550	8	WL495-LED	19	SL150	27
AL700	8	GL100	19	SL25-LED	27
AL750	8	GL100-bt	19	SL25-bt	27
AL800	8	GL150	19	SL35-LED	27
AL850	8	GL150-bt	19	SL35-bt	27
ALSTEM12	9	GL160	20	SL26-LED	28
ALSTEM18	9	GL160-bt	20	SL36-LED	28
ALSTEM24	9	GL170	20	SL200	28
ALSTEMADJ	9	GL170-bt	20	SL300	28
ALSTEM12-bt	9	GL180	21	SL65-LED	28
ALSTEM18-bt	9	GL180-bt	21	SL75-LED	29
PL100	10	GL190	21	SL85-LED	29
PL100-bt	10	GL190-bt	21	SL60-bt	29
HSC-PL1	10	GL300	22	SL70	29
HSC-PL2	11	GL300-bt	22	SL70-bt	29
HSC-PL3	11	GL310	22	SL80-bt	30
HSC-PL4	12	GL310-bt	22	POST50	30
PL200	12	GL350	23	POST100	30
PL250	13	GL350-bt	23	TAPE-BT-5FT	30

TAPE-BT-15FT	30	BTRE-SM	39	LMR16-LED-6W-F-2700K	47
TAPE-LED-5FT	30	BTRE-PLUGIN	39	LPAR36-LED4W-F	48
TAPE-LED-15FT	30	Accessories	42	LPAR36-LED4W-WF	48
TAPE-LED-15FT-LL	30	TREEMOUNT	42	LPAR36-LED8W-F	48
TAPE-LED-30FT	30	STAKE-P1	42	LPAR36-LED8W-WF	48
TAPE-SLV-3	31	STAKE-P2	42	LPAR36-LED10W-F	48
WS100	31	PERMAPOST	42	LPAR36-LED10W-WF	48
WS200	31	RMB	42	LPAR36-LED750LM	48
WS350-bt	31	GUTTERMOUNT	42	LBIPIN-LED-200lm	48
Specialty	32	L-ADAPTER	43	LBIPIN-LED-250lm	48
UL100	32	T-ADAPTER	43	LBIPIN-LED-350lm	48
UL100-50FT	32	A-LOC-50	43	L3156-LED-200lm	48
UL100-bt	32	RISER6	43	L3156-LED-250lm	48
UL395-LED	32	RISER12	43	L921T5-LED-200lm	48
ML15-LED	32	RISER18	43	LBA15S-LED-200lm	48
ML25-LED	33	RISERADJ	43	LBA15D-LED-200lm	48
ML35-LED	33	CGWL01-GRATE	43	Marketing Material	49
ML45-LED	33	CGWL02-TOP	43	Warranty	51
ML55-LED	33	HEXLOUVER-MR16	44		
ML65-LED	33	HEXLOUVER-PAR36	44		
GOLF100	34	MR16LENS-FROSTED	44		
GOLF50-bt	34	PAR36LENS-FROSTED	44		
TIKI	35	Demo Kits	45		
ALSTEM60	35	DEMOKIT-8	45		
Power & Control	36	DEMOKIT-8-bt	45		
IT2-150	36	Lamps	46		
IT2-300	36	BT-ALLY-MR16	46		
XF150	36	BT-ALLY-PAR36	46		
XF300	36	BT-ALLY-G4	46		
XF600	36	BT-ALLY-A19	46		
ITIMERPRO	37	LMR11-LED-4W-F	47		
ITIMERPRO-2	37	LMR16-LED-4W-NS	47		
PC	37	LMR16-LED-4W-F	47		
TIMER2	37	LMR16-LED-4W-WF	47		
TF150	38	LMR16-LED-4W-250lm	47		
TF200	38	LMR16-LED-4W-F-2700K	47		
TF300	38	LMR16-LED-5W-NS	47		
CS100	38	LMR16-LED-5W-F	47		
CS150	38	LMR16-LED-5W-WF	47		
BT System	39	LMR16-LED-5W-310lm	47		
BTRE	39	LMR16-LED-5W-F-2700K	47		
BTRE-5PK	39	LMR16-LED-6W-F	47		

ACCENT / UPLIGHTS

BL50

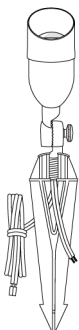

Part #	With No Lamp	Price \$	Finish	Price \$	With MR11 Lamp	Price \$
BL50		84.00	Standard (Aged Brass)	+0.00	-LED4W (175lm)	122.59
			-BLK (Black Overcoat)	+0.00		

Description: Accent / Uplight, Cast Brass, Aged Brass Finish, Optional Black Overcoat, MR11 Socket (Lamp Not Included), Slotted 8.5" Ground Stake, Double Wire Lead (18' & 25')

To add optional lamp, add the suffix noted to the base part number. Example: BL50-LED4W for a BL50 with a 4W lamp.

BL110

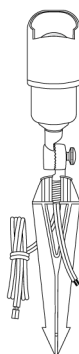

Part #	With No Lamp	Price \$	Finish Options	Price \$	With MR16 Lamp	Price \$
BL110		98.41	Standard (Aged Brass)	+0.00	-LED4W (250lm)	129.79
			-BLK (Black Overcoat)	+0.00	-LED5W (310lm)	
					-LED6W (410lm)	137.00

Description: Accent / Uplight, Cast Brass, Aged Brass Finish, Optional Black Overcoat, MR16 Socket (Lamp Not Included), Slotted 8.5" Ground Stake, Double Wire Lead (18" & 25')

To add optional finish or lamp, add the suffixes noted to the base part number. Example: BL110-LED4W for a BL110 with a 4W lamp. For additional beam angles see the lamps page 47.

HSC-BL1



Part #	With No Lamp	Price \$	Finish	Price \$	With MR16 Lamp	Price \$
HSC-BL1		168.80	Sand-Cast Bronze	+0.00	-LED4W (250lm)	200.18
					-LED5W (310lm)	
					-LED6W (410lm)	207.39

Description: Accent / Uplight, Cast Bronze, Sand Cast Bronze, MR16 Socket (Lamp Not Included), Cast Bronze 8.5" Ground Stake, Wire Lead (25')

To add optional lamp, add the suffix noted to the base part number. Example: HSC-BL1-LED4W for a HSC-BL1 with a 4W lamp. For additional beam angles see the lamps page 47.

HSC-BL2



Part #	With No Lamp	Price \$	Finish	Price \$	With MR11 Lamp	Price \$
HSC-BL2		153.93	Sand-Cast Bronze	+0.00	-LED4W (175lm)	192.52

Description: Accent / Uplight, Cast Bronze, Sand Cast Bronze, MR11 Socket (Lamp Not Included), Cast Bronze 8.5" Ground Stake, Wire Lead (25')

To add optional lamp, add the suffix noted to the base part number. Example: HSC-BL2-LED4W for a HSC-BL2 with a 4W lamp. For additional beam angles see the lamps page 47.

HSC-BL3

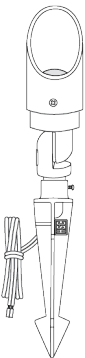

Part #	Price \$	With LED Module	Finish	Price \$
HSC-BL3-BT	268.54	Integrated bt Module (Bluetooth RGBW)	Sand-Cast Bronze	+0.00

Description: Accent / Uplight, Cast Bronze, Sand Cast Bronze, Integrated bt Module, Cast Bronze 8.5" Ground Stake, Wire Lead (25')

BL200

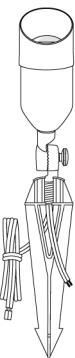

Part #	With No Lamp	Price \$	Finish Options	Price \$	With MR16 Lamp	Price \$
BL200		121.45	Standard (Aged Brass)	+0.00	-LED4W (250lm)	152.83
			-BLK (Black Overcoat)	+0.00	-LED5W (310lm)	

Description: Accent / Uplight, Cast Brass, Aged Brass Finish, Optional Black Overcoat, MR16 Socket (Lamp Not Included), Slotted 8.5" Ground Stake, Double Wire Lead (18" & 25')

Part #	Price \$	With LED Module	Finish	Price \$
BL200-bt	228.56	Integrated bt Module (Bluetooth RGBW)	Standard (Aged Brass)	+0.00
			-BLK (Black Overcoat)	+0.00

Description: Accent / Uplight, Cast Brass, Aged Brass Finish, Optional Black Overcoat, Integrated bt Module, Slotted 8.5" Ground Stake, Double Wire Lead (18" & 25')

To add optional finish or lamp, add the suffixes noted to the base part number. Example: BL200-LED4W for a BL200 with a 4W lamp. For additional beam angles see the lamps page 47.

ACCENT / UPLIGHTS

BL900

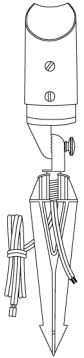

Part #	With No Lamp	Price \$	Finish	Price \$	With MR16 Lamp	Price \$
BL900		129.23	Standard (Aged Brass)	+0.00	-LED4W (250lm)	160.61
			-BLK (Black Overcoat)	+0.00	-LED5W (310lm)	
					-LED6W (410lm)	167.82

Description: Accent / Uplight, Cast Brass, Aged Brass Finish, Optional Black Overcoat, MR16 Socket (Lamp Not Included), Slotted 8.5" Ground Stake, Double Wire Lead (18" & 25')

To add optional lamp, add the suffix noted to the base part number. Example: BL900-LED4W for a BL900 with a 4W lamp. For additional beam angles see the lamps page 47.

Part #	Price \$	With LED Module	Finish	Price \$
BL900-bt	236.34	Integrated bt Module (Bluetooth RGBW)	Standard (Aged Brass)	+0.00
			-BLK (Black Overcoat)	+0.00

Description: Accent / Uplight, Cast Brass, Aged Brass Finish, Optional Black Overcoat, Integrated bt Module, Slotted 8.5" Ground Stake, Double Wire Lead (18" & 25')

BL300

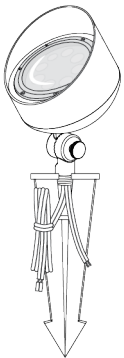

Part #	With No Lamp	Price \$	Finish Options	Price \$	With PAR36 Lamp	Price \$
BL300		158.51	Standard (Aged Brass)	+0.00	-LED4W (250lm)	245.59
			-BLK (Black Overcoat)	+0.00	-LED8W (300lm)	261.78
					-LED10W (400lm)	278.56

Description: Accent / Uplight, Cast Brass, Aged Brass Finish, Optional Black Overcoat, Spade Connectors for LPAR36 (Lamp Not Included), Slotted 8.5" Large Ground Stake, Double Wire Lead (18" & 25')

To add optional finish or lamp, add the suffixes noted to the base part number. Example: BL300-BLK-LED4W for a BL300 with black overcoat and a 4W lamp. For additional beam angles see the lamps page 47.

BL395-LED BL400-bt

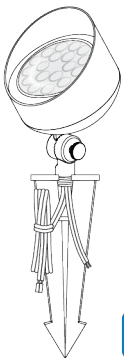

Part #	Price \$	With LED Module	Finish	Price \$
BL395-LED	259.01	Integrated 1,200 Lumen LED Module (3000k)	Standard (Aged Brass)	+0.00
			-BLK (Black Overcoat)	+0.00

Description: Accent / Uplight, Cast Brass, Aged Brass Finish, Optional Black Overcoat, Integrated 1200 Lumen LED Included, Slotted 8.5" Large Ground Stake, Double Wire Lead (18" & 25')

Part #	Price \$	With LED Module	Finish	Price \$
BL400-bt	301.01	Integrated bt Module (Bluetooth RGBW)	Standard (Aged Brass)	+0.00
			-BLK (Black Overcoat)	+0.00

Description: Accent / Uplight, Cast Brass, Aged Brass Finish, Optional Black Overcoat, Integrated bt Module Included, Slotted 8.5" Large Ground Stake, Double Wire Lead (18" & 25')

PL300

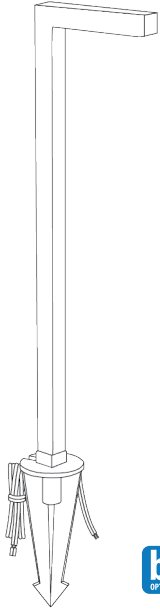

Part #	With No Lamp	Price \$	Finish Options	Price \$	With G4 Lamp	Price \$
PL300		103.04	Standard (Aged Brass)	+0.00	-LED (200lm)	128.15
			-BLK (Black Overcoat)	+0.00		

Description: Area & Path Light, Solid Brass, Aged Brass Finish, Optional Black Overcoat, G4 Bi-Pin Socket (Lamp Not Included), Slotted 8.5" Large Ground Stake, Double Wire Lead (18" & 25')

To add optional finish or lamp, add the suffixes noted to the base part number. Example: PL300-BLK-LED for a PL300 in black overcoat with the LBIPIN-LED-200lm lamp included.

Part #	Price \$	With LED Module	Finish Options	Price \$
PL300-bt	245.05	Integrated bt Module (Bluetooth RGBW)	Standard (Aged Brass)	+0.00
			-BLK (Black Overcoat)	+0.00

Description: Area & Path Light, Solid Brass, Aged Brass Finish, Optional Black Overcoat, Integrated bt Module, Slotted 8.5" Large Ground Stake, Double Wire Lead (18" & 25')

To add optional finish or lamp, add the suffixes noted to the base part number. Example: PL300-bt-BLK for a PL300-bt in black overcoat.

PL600-LED

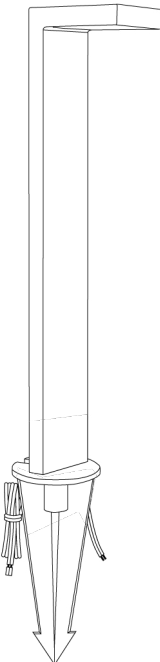

Part #	Price \$	With LED Module	Finish Options	Price \$
PL600-LED	244.00	Integrated LED Module (3000k)	Standard (Aged Brass)	+0.00
			-BLK (Black Overcoat)	+0.00

Description: Area & Path Light, Solid Brass, Aged Brass Finish, Optional Black Overcoat, Integrated LED Module, Slotted 14" Giant Ground Stake, Double Wire Lead (18" & 25')

To add optional finish, add the suffixes noted to the base part number. Example: PL600-LED-BLK for a PL600-LED with a black overcoat.

AREA & PATH

AL100



Part #	Price \$	Finish Options
AL100	51.41	Standard (Aged Brass) -BLK (Black Overcoat)

AL150



Part #	Price \$	Finish Options
AL150	60.75	Standard (Aged Brass) -BLK (Black Overcoat)

AL250

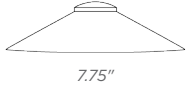

Part #	Price \$	Finish Options
AL250	68.22	Standard (Aged Brass) -BLK (Black Overcoat)

AL300



Part #	Price \$	Finish
AL300	75.29	Standard (Aged Brass) -BLK (Black Overcoat)

AL400



Part #	Price \$	Finish
AL400	68.22	Standard (Aged Brass) -BLK (Black Overcoat)

AL500

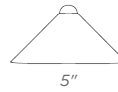

Part #	Price \$	Finish
AL500	41.82	Standard (Aged Brass) -BLK (Black Overcoat)

AL550



Part #	Price \$	Finish Options
AL550	31.78	Standard (Aged Brass) -BLK (Black Overcoat)

Description: Area & Path Hat, Cast Brass, Aged Brass Finish, Optional Black Overcoat, Includes Frosted and Clear Plastic Lenses with Rubber Gaskets

To add optional finish, add the suffix noted to the base part number. Example: AL550-BLK for a AL550 in black overcoat.

AL700

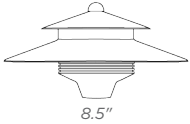

Part #	Price \$	Finish
AL700	126.42	Standard (Aged Brass) -BLK (Black Overcoat)

AL750

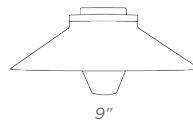

Part #	Price \$	Finish
AL750	177.82	Standard (Aged Brass) -BLK (Black Overcoat)

AL800

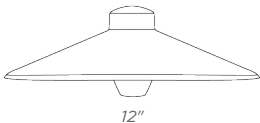

Part #	Price \$	Finish
AL800	148.04	Standard (Aged Brass) -BLK (Black Overcoat)

AL850

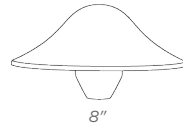

Part #	Price \$	Finish
AL850	145.46	Standard (Aged Brass) -BLK (Black Overcoat)

Description: Area & Path Hat, Cast Brass, Aged Brass Finish, Optional Black Overcoat, Includes a Frosted Lens and Aged Brass Collar

Note: AL700, AL750, AL800, AL850 are not compatible with the ALSTEM12-BT or ALSTEM18-BT stems.

ALSTEM12
ALSTEM18
ALSTEM24
ALSTEM60

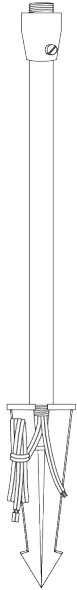

Part #	With No Lamp	Finish Options	With G4 Lamp	Price \$
ALSTEM12	90.30	Standard (Aged Brass) +0.00	-LED (200lm)	115.41
ALSTEM18	97.90	-BLK (Black Overcoat) +0.00	-LED (200lm)	123.01
ALSTEM24	119.95		-LED (200lm)	145.06
ALSTEM60	261.68		-LED (200lm)	286.79

Description: Area & Path Light Stem, Cast Brass, Aged Brass Finish, Optional Black Overcoat, G4 Bi-Pin Socket (Lamp Not Included), Adjustable Collar, Slotted 8.5" Large Ground Stake, Double Wire Lead (18" & 25')

To add optional finish or lamp, add the suffixes noted to the base part number. Example: ALSTEM12-BLK-LED for a ALSTEM12 in black overcoat with the LBIPIN-LED-200lm lamp included.

ALSTEM60 pictured on page 35

ALSTEM12-BT
ALSTEM18-BT



Part #	Price \$	With LED Module	Finish Options
ALSTEM12-bt	193.65	Integrated bt Module (Bluetooth RGBW)	Standard (Aged Brass) +0.00
ALSTEM18-bt	201.55		-BLK (Black Overcoat) +0.00

Description: Area & Path Light Stem, Cast Brass, Aged Brass Finish, Optional Black Overcoat, Integrated bt Module, Adjustable Collar, Slotted 8.5" Large Ground Stake, Double Wire Lead (18" & 25')

To add optional finish, add the suffix noted to the base part number. Example: ALSTEM12-bt-BLK for a ALSTEM12-bt in black overcoat.

AREA & PATH

PL100

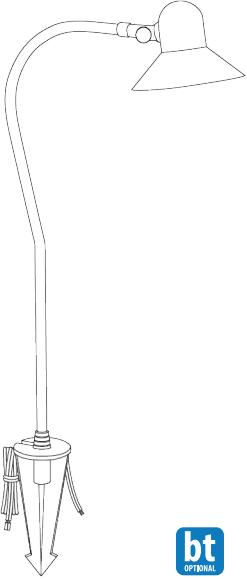

Part #	With No Lamp	Price \$	Finish Options	Price \$	With G4 Lamp	Price \$
PL100		163.28	Standard (Aged Brass)	+0.00	-LED (200lm)	188.39
			-BLK (Black Overcoat)	+0.00		

Description: Area & Path Light, Solid Brass, Aged Brass Finish, Optional Black Overcoat, G4 Bi-Pin Socket (Lamp Not Included), Slotted 8.5" Large Ground Stake, Double Wire Lead (18" & 25')

To add optional finish or lamp, add the suffixes noted to the base part number. Example: PL100-BLK-LED for a PL100 in black overcoat with the LBIPIN-LED-200lm lamp included.

Part #	Price \$	With LED Module	Finish Options	Price \$
PL100-bt	269.52	Integrated bt Module (Bluetooth RGBW)	Standard (Aged Brass)	+0.00
			-BLK (Black Overcoat)	+0.00

Description: Area & Path Light, Solid Brass, Aged Brass Finish, Optional Black Overcoat, Integrated bt Module, Slotted 8.5" Large Ground Stake, Double Wire Lead (18" & 25')

HSC-PL1

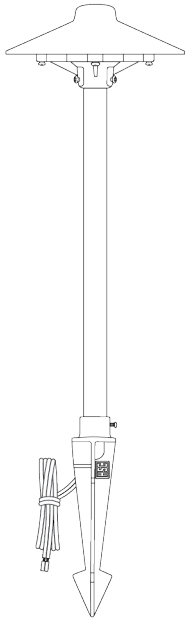

Part #	With No Lamp	Price \$	Finish	Price \$	With G4 Lamp	Price \$
HSC-PL1		211.11	Sand-Cast Bronze	+0.00	-LED (200lm)	236.22

Description: Area & Path Light, Cast Bronze, Sand Cast Bronze, G4 Bi-Pin Socket (Lamp Not Included), Cast Bronze 8.5" Ground Stake, Wire Lead (25')

To add optional lamp, add the suffix noted to the base part number. Example: HSC-PL1-LED for a HSC-PL1 with a LBIPIN-LED-200lm lamp included.

HSC-PL2

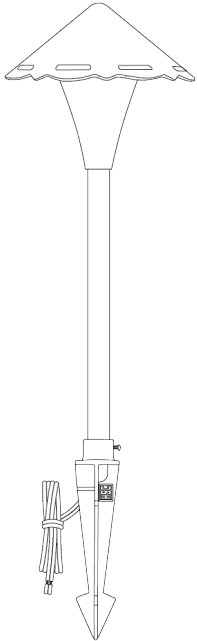

Part #	With No Lamp	Price \$	Finish	Price \$	With G4 Lamp	Price \$
HSC-PL2		388.77	Sand-Cast Bronze	+0.00	-LED (200lm)	413.88

Description: Area & Path Light, Cast Bronze, Sand Cast Bronze, G4 Bi-Pin Socket (Lamp Not Included), Cast Bronze 8.5" Ground Stake, Wire Lead (25')

To add optional lamp, add the suffix noted to the base part number. Example: HSC-PL2-LED for a HSC-PL2 with a LBIPIN-LED-200lm lamp included.

HSC-PL3

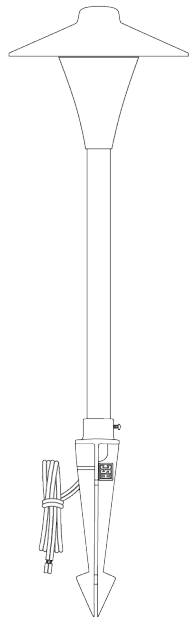

Part #	With No Lamp	Price \$	Finish	Price \$	With G4 Lamp	Price \$
HSC-PL3		366.74	Sand-Cast Bronze	+0.00	-LED (200lm)	391.85

Description: Area & Path Light, Cast Bronze, Sand Cast Bronze, G4 Bi-Pin Socket (Lamp Not Included), Cast Bronze 8.5" Ground Stake, Wire Lead (25')

To add optional lamp, add the suffix noted to the base part number. Example: HSC-PL3-LED for a HSC-PL3 with a LBIPIN-LED-200lm lamp included.

AREA & PATH

HSC-PL4

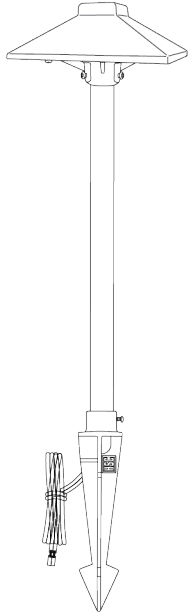

Part #	With No Lamp	Price \$	Finish	Price \$	With G4 Lamp	Price \$
HSC-PL4		225.65	Sand-Cast Bronze	+0.00	-LED (200lm)	250.76

Description: Area & Path Light, Cast Bronze, Sand Cast Bronze, G4 Bi-Pin Socket (Lamp Not Included), Cast Bronze 8.5" Ground Stake, Wire Lead (25')

To add optional lamp, add the suffix noted to the base part number. Example: HSC-PL4-LED for a HSC-PL4 with a LBIPIN-LED-200lm lamp included.

PL200

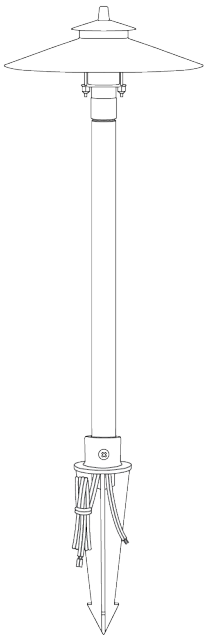

Part #	With No Lamp	Price \$	Finish	Price \$	With G4 Lamp	Price \$
PL200		178.79	Standard (Aged Brass)	+0.00	-LED (200lm)	203.90
			-BLK (Black Overcoat)	+0.00		

Description: Area & Path Light, Solid Brass, Aged Brass Finish, Optional Black Overcoat, Adjustable Stem, G4 Bi-Pin Socket (Lamp Not Included), Solid Brass Ground Stake, Double Wire Lead (18" & 25')

To add optional lamp, add the suffix noted to the base part number. Example: PL200-LED for a PL200 with the LBIPIN-LED-200lm lamp included.

PL250

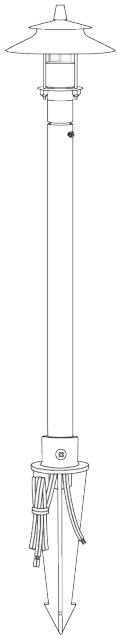

Part #	With No Lamp	Price \$	Finish	Price \$	With G4 Lamp	Price \$
PL250		160.88	Standard (Aged Brass)	+0.00	-LED (200lm)	185.99
			-BLK (Black Overcoat)	+0.00		

Description: Area & Path Light, Solid Brass, Aged Brass Finish, Optional Black Overcoat, Adjustable Stem, G4 Bi-Pin Socket (Lamp Not Included), Solid Brass Ground Stake, Double Wire Lead (18" & 25')

To add optional lamp, add the suffix noted to the base part number. Example: PL250-LED for a PL250 with the LBIPIN-LED-200lm lamp included.

BOLLARD100

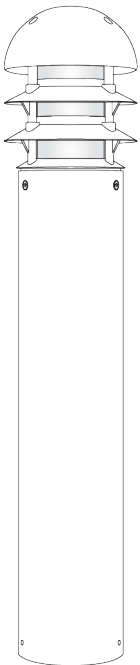

Part #	With No Lamp	Price \$	Finish Options	Price \$	With G4 Lamp	Price \$
BOLLARD100		370.74	Standard (Aged Brass)	+0.00	-LED (350lm)	395.85
			-BLK (Black Overcoat)	+0.00		

Description: Area & Path Light, Brass 3-Tier Cover and Louvers, Stainless Steel Post, Aged Brass Finish, Optional Black Overcoat, G4 Bi-Pin Socket (Lamp Not Included), Aluminum Mounting Base, Three Anchor L-Bolts, Wire Lead (36")

To add optional finish or lamp, add the suffixes noted to the base part number. Example: BOLLARD100-BLK-LED for a BOLLARD100 in black overcoat with the LBIPIN-LED-350lm lamp included.

WALL WASH

FL50

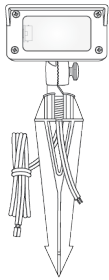

Part #	With No Lamp	Price \$	Finish	Price \$	With G4 Lamp	Price \$	Frosted Face Plate	
FL50		113.64	Standard (Aged Brass)	+0.00	-LED (200lm) -LED250lm (250lm)	138.75	-FFP	+0.00
			-BLK (Black Overcoat)	+0.00				

Description: Wall Wash Light, Cast Brass, Aged Brass Finish, Optional Black Overcoat, G4 Bi-Pin Socket (Lamp Not Included), Slotted 8.5" Ground Stake, Double Wire Lead (18" & 25')

To add optional finish, lens, or lamp, add the suffixes noted to the base part number. Example: FL50-FFP-LED for a FL50 with the frosted face plate with the LBIPIN-LED-200lm lamp included.

Part #	Price \$	With LED Module	Finish Options	Price \$
FL50-bt	217.92	Integrated bt Module (Bluetooth RGBW)	Standard (Aged Brass)	+0.00
			-BLK (Black Overcoat)	+0.00

Description: Wall Wash Light, Cast Brass, Aged Brass Finish, Optional Black Overcoat, Integrated bt Module, Slotted 8.5" Ground Stake, Double Wire Lead (18" & 25')

To add optional finish or lamp, add the suffixes noted to the base part number. Example: FL50-bt-BLK for a FL50-bt in black overcoat.

FL100

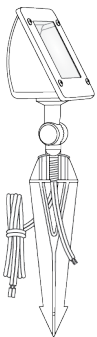

Part #	With No Lamp	Price \$	Finish	Price \$	With G4 Lamp	Price \$	Frosted Face Plate	
FL100		122.10	Standard (Aged Brass)	+0.00	-LED (200lm) -LED250lm (250lm)	147.21	-FFP	+0.00
			-BLK (Black Overcoat)	+0.00				

Description: Wall Wash Light, Cast Brass, Aged Brass Finish, Optional Black Overcoat, G4 Bi-Pin Socket (Lamp Not Included), Slotted 8.5" Ground Stake, Double Wire Lead (18" & 25')

To add optional finish, lens, or lamp, add the suffixes noted to the base part number. Example: F100-FFP-LED for a FL100 with the frosted face plate with the LBIPIN-LED-200lm lamp included.

FL200

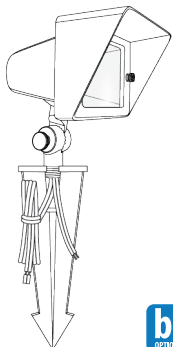

Part #	With No Lamp	Price \$	Finish Options	Price \$	With MR16 Lamp	Price \$
FL200		216.91	Standard (Aged Brass)	+0.00	-LED4W (250lm) -LED5W (310lm)	248.29
			-BLK (Black Overcoat)	+0.00	-LED6W (410lm)	255.50

Description: Wall Wash Light, Cast Brass, Aged Brass Finish, Optional Black Overcoat, Faceplate with Clear Lens, Optional Frosted Lens, MR16 Socket (Lamp Not Included), Slotted 8.5" Large Ground Stake, Double Wire Lead (18" & 25')

To add optional finish or lamp, add the suffixes noted to the base part number. Example: FL200-BLK-LED for a FL200 in black overcoat and a 4W lamp. For additional beam angles see the lamps page 47.

Part #	Price \$	With LED Module	Finish	Price \$
FL200-bt	360.57	Integrated bt Module (Bluetooth RGBW)	Standard (Aged Brass)	+0.00
			-BLK (Black Overcoat)	+0.00

Description: Wall Wash Light, Cast Brass, Aged Brass Finish, Optional Black Overcoat, Integrated bt Module, Slotted 8.5" Large Ground Stake, Double Wire Lead (18" & 25')

DL50

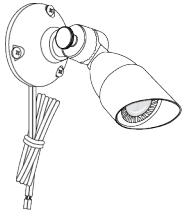

Part #	With No Lamp	Price \$	Finish	Price \$	With MR11 Lamp	Price \$
DL50		104.87	Standard (Aged Brass)	+0.00	-LED4W (175lm)	143.46
			-BLK (Black Overcoat)	+0.00		

Description: Down Light, Cast Brass, Aged Brass Finish, Optional Black Overcoat, MR11 Socket (Lamp Not Included), Round Canopy Mounting Base, Wire Lead (25')

To add optional lamp, add the suffix noted to the base part number. Example: DL50-LED4W for a DL50 with a 4W lamp.

DL100

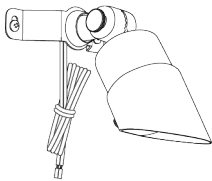

Part #	With No Lamp	Price \$	Finish	Price \$	With MR16 Lamp	Price \$
DL100		141.27	Standard (Aged Brass)	+0.00	-LED4W (250lm)	172.59
			-BLK (Black Overcoat)	+0.00	-LED5W (310lm)	
					-LED6W (410lm)	179.86

Description: Down Light, Cast Brass, Aged Brass Finish, Optional Black Overcoat, MR16 Socket (Lamp Not Included), Brass Tree-Mounted Bracket and Brass Nut, Wire Lead (25')

To add optional finish or lamp, add the suffixes noted to the base part number. Example: DL100-LED4W for a DL100 with a 4W lamp. For additional beam angles see the lamps page 47.

DL200

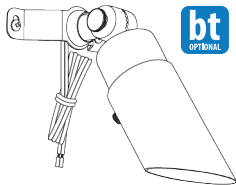

Part #	With No Lamp	Price \$	Finish Options	Price \$	With MR16 Lamp	Price \$
DL200		167.32	Standard (Aged Brass)	+0.00	-LED4W (250lm)	198.70
			-BLK (Black Overcoat)	+0.00	-LED5W (310lm)	
					-LED6W (410lm)	205.91

Description: Down Light, Cast Brass, Aged Brass Finish, Optional Black Overcoat, MR16 Socket (Lamp Not Included), Brass Tree-Mounted Bracket and Brass Nut, Wire Lead (25')

To add optional finish or lamp, add the suffixes noted to the base part number. Example: DL200-BLK-LED4W for a DL200 with black overcoat and a 4W lamp. For additional beam angles see the lamps page 47.

Part #	Price \$	With LED Module	Finish	Price \$
DL200-bt	273.75	Integrated bt Module (Bluetooth RGBW)	Standard (Aged Brass)	+0.00
			-BLK (Black Overcoat)	

Description: Down Light, Cast Brass, Aged Brass Finish, Optional Black Overcoat, Integrated bt Module, Brass Tree-Mounted Bracket and Brass Nut, Wire Lead (25')

DOWN LIGHTS

HL100



Part #	With No Lamp	Price \$	Finish	Price \$	With MR16 Lamp	Price \$
HL100		142.11	Standard (Aged Brass)	+0.00	-LED4W (250lm)	173.49
			-BLK (Black Overcoat)	+0.00	-LED5W (310lm)	
					-LED6W (410lm)	180.70

Description: Down Light, Cast Brass, Aged Brass Finish, Optional Black Overcoat, MR16 Socket (Lamp Not Included), 18" Hanging Chain, Wire Lead (25')

To add optional lamp, add the suffixes noted to the base part number. Example: HL100-LED for a HL100 with a 4W lamp. For additional beam angles see the lamps page 47.

Part #	Price \$	With LED Module	Finish	Price \$
HL100-bt	247.53	Integrated bt Module (Bluetooth RGBW)	Standard (Aged Brass)	+0.00
			-BLK (Black Overcoat)	+0.00

Description: Down Light, Cast Brass, Aged Brass Finish, Optional Black Overcoat, Integrated bt Module, 18" Hanging Chain, Wire Lead (25')

HL200



Part #	With No Lamp	Price \$	Finish	Price \$	With G4 Lamp	Price \$
HL200		145.25	Standard (Aged Brass)	+0.00	-LED (200lm)	170.36
			-BLK (Black Overcoat)	+0.00		

Description: Down Light, Cast Brass, Aged Brass Finish, Optional Black Overcoat, G4 Bi-Pin Socket (Lamp Not Included), 18" Hanging Chain, Wire Lead (25')

To add optional lamp, add the suffixes noted to the base part number. Example: HL200-LED for a HL200 with the LBIPIN-LED-200lm lamp included.

Part #	Price \$	With LED Module	Finish	Price \$
HL200-bt	250.78	Integrated bt Module (Bluetooth RGBW)	Standard (Aged Brass)	+0.00
			-BLK (Black Overcoat)	+0.00

Description: Down Light, Cast Brass, Aged Brass Finish, Optional Black Overcoat, Integrated bt Module, 18" Hanging Chain, Wire Lead (25')

WL100

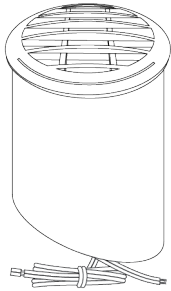

Part #	With No Lamp	Price \$	Finish	Price \$	With PAR36 Lamp	Price \$
WL100		93.14	Standard (Black)	+0.00	-LED4W (250lm)	180.22
					-LED8W (300lm)	196.41
					-LED10W (400lm)	213.19

Description: In-Ground Light, ABS Plastic Can, ABS Grated Lid, Spade Connectors for LPAR36 (Lamp Not Included), Double Wire Lead (18" & 25')

To add optional lamp, add the suffix noted to the base part number. Example: WL100-LED4W for a WL100 with a 4W lamp. For additional beam angles see the lamps page 47.

WL200

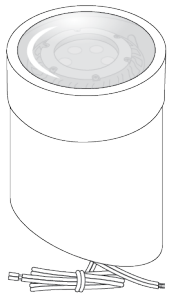

Part #	With No Lamp	Price \$	Finish	Price \$	With PAR36 Lamp	Price \$
WL200		117.24	Standard (Aged Brass)	+0.00	-LED4W (250lm)	204.32
			-BLK (Black Overcoat)	+0.00	-LED8W (300lm)	220.51
					-LED10W (400lm)	237.29

Description: In-Ground Light, ABS Plastic Can, Cast Brass Lid, Aged Brass Finish, Optional Black Overcoat, Spade Connectors for LPAR36 (Lamp Not Included), Double Wire Lead (18" & 25')

To add optional lamp, add the suffix noted to the base part number. Example: WL200-LED4W for a WL200 with a 4W lamp. For additional beam angles see the lamps page 48.

WL300

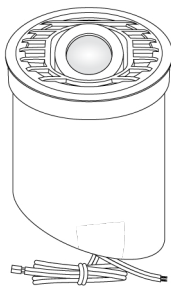

Part #	With No Lamp	Price \$	Finish	Price \$	With MR16 Lamp	Price \$
WL300		235.23	Standard (Aged Brass)	+0.00	-LED4W (250lm)	266.61
			-BLK (Black Overcoat)	+0.00	-LED5W (310lm)	
					-LED6W (410lm)	273.82

Description: In-Ground Light, ABS Plastic Can, Cast Brass Lid, Aged Brass Finish, Optional Black Overcoat, Aimable and Adjustable Lamp Assembly, MR16 Socket (Lamp Not Included), Double Wire Lead (18" & 25')

To add optional lamp, add the suffix noted to the base part number. Example: WL300-LED4W for a WL300 with a 4W lamp. For additional beam angles see the lamps page 47.

IN-GROUND

CGWL01

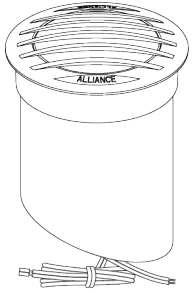

Part #	With No Lamp	Price \$	Finish Options	Price \$	With PAR36 Lamp	Price \$
CGWL01		187.50	Standard (Aged Brass)	+0.00	-LED4W (250lm)	274.58
			-BLK (Black Overcoat)	+0.00	-LED8W (300lm)	290.77
					-LED10W (400lm)	307.55

Description: In-Ground Light, ABS Plastic Can, Heavy Duty Brass Grated Lid, Aged Brass Finish, Optional Black Overcoat, Spade Connectors for LPAR36 (Lamp Not Included), Double Wire Lead (18" & 25')

To add optional finish or lamp, add the suffixes noted to the base part number. Example: CGWL01-BLK-LED4W for a CGWL01 with black overcoat and a 4W lamp. For additional beam angles see the lamps page 48.

CGWL02

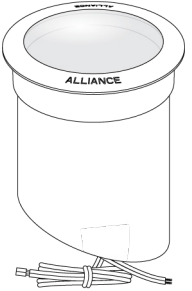

Part #	With No Lamp	Price \$	Finish Options	Price \$	With PAR36 Lamp	Price \$
CGWL02		187.50	Standard (Aged Brass)	+0.00	-LED4W (250lm)	274.58
			-BLK (Black Overcoat)	+0.00	-LED8W (300lm)	290.77
					-LED10W (400lm)	307.55

Description: In-Ground Light, ABS Plastic Can, Heavy Duty Brass Lid, Aged Brass Finish, Optional Black Overcoat, Spade Connectors for LPAR36 (Lamp Not Included), Double Wire Lead (18" & 25')

To add optional finish or lamp, add the suffixes noted to the base part number. Example: CGWL02-BLK-LED4W for a CGWL02 with black overcoat and a 4W lamp. For additional beam angles see the lamps page 48.

WL400-bt

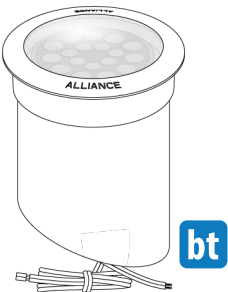

Part #	Price \$	With LED Module	Finish Options	Price \$
WL400-bt	285.88	Integrated bt Module (Bluetooth RGBW)	Standard (Aged Brass)	+0.00
			-BLK (Black Overcoat)	+0.00

Description: In-Ground Light, ABS Plastic Can, Cast Brass Lid, Aged Brass Finish, Optional Black Overcoat, Integrated bt Module, Double Wire Lead (18" & 25')

To add optional finish, add the suffix noted to the base part number. Example: WL400-BT-BLK for a black overcoat.

WL495-LED

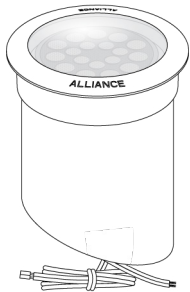

Part #	Price \$	With LED Module	Finish	Price \$
WL495-LED	259.01	Integrated 1,200 Lumen LED Module (3000k)	Standard (Aged Brass)	+0.00
			-BLK (Black Overcoat)	+0.00

In-Ground Light, ABS Plastic Can, Cast Brass Lid, Aged Brass Finish, Optional Black Overcoat, Integrated 1200 Lumen LED Included, Double Wire Lead (18" & 25')

GL100

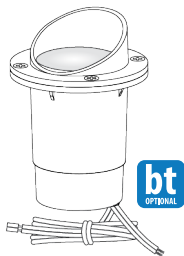

Part #	With No Lamp	Price \$	Finish Options	Price \$	With MR16 Lamp	Price \$
GL100		150.76	Standard (Aged Brass)	+0.00	-LED4W (250lm)	182.14
			-BLK (Black Overcoat)	+0.00	-LED5W (310lm)	
					-LED6W (410lm)	189.35

Description: In-Ground Light, Cast Brass, Shroud with Convex Lens, Aged Brass Finish, Optional Black Overcoat, MR16 Socket (Lamp Not Included), 2.75" PVC Installation Sleeve, Double Wire Lead (18" & 25')

To add optional finish or finish or lamp, add the suffix noted to the base part number. Example: GL100-BLK-LED4W for a GL100 with a black overcoat and a 4W lamp. For additional beam angles see the lamps page 47.

Part #	Price \$	With LED Module	Finish Options	Price \$
GL100-bt	255.85	Integrated bt Module (Bluetooth RGBW)	Standard (Aged Brass)	+0.00
			-BLK (Black Overcoat)	+0.00

Description: In-Ground Light, Cast Brass, Shroud with Convex Lens, Aged Brass Finish, Optional Black Overcoat, Integrated bt Module, 2.75" PVC Installation Sleeve, Double Wire Lead (18" & 25')

To add optional finish, add the suffix noted to the base part number. Example: GL100-BT-BLK for a GL100-BT with a black overcoat.

GL150

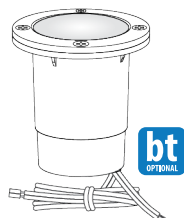

Part #	With No Lamp	Price \$	Finish Options	Price \$	With MR16 Lamp	Price \$
GL150		150.76	Standard (Aged Brass)	+0.00	-LED4W (250lm)	182.14
			-BLK (Black Overcoat)	+0.00	-LED5W (310lm)	
					-LED6W (410lm)	189.35

Description: In-Ground Light, Cast Brass, Flat Lid with Convex Lens, Aged Brass Finish, Optional Black Overcoat, MR16 Socket (Lamp Not Included), 2.75" PVC Installation Sleeve, Double Wire Lead (18" & 25')

To add optional finish or lamp, add the suffix noted to the base part number. Example: GL150-BLK-LED4W for a GL150 with a black overcoat and a 4W lamp. For additional beam angles see the lamps page 47

Part #	Price \$	With LED Module	Finish Options	Price \$
GL150-bt	255.85	Integrated bt Module (Bluetooth RGBW)	Standard (Aged Brass)	+0.00
			-BLK (Black Overcoat)	+0.00

Description: In-Ground Light, Cast Brass, Flat Lid with Convex Lens, Aged Brass Finish, Optional Black Overcoat, Integrated bt Module, 2.75" PVC Installation Sleeve, Double Wire Lead (18" & 25')

To add optional finish, add the suffix noted to the base part number. Example: GL150-BT-BLK for a GL150-BT with a black overcoat.

IN-GROUND

GL160

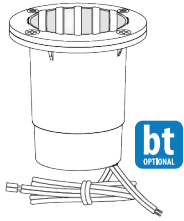

Part #	With No Lamp	Price \$	Finish Options	Price \$	With MR16 Lamp	Price \$
GL160		167.82	Standard (Aged Brass)	+0.00	-LED4W (250lm)	199.20
			-BLK (Black Overcoat)	+0.00	-LED5W (310lm)	
					-LED6W (410lm)	206.41

Description: In-Ground Light, Cast Brass, Grated Lid with Convex Lens, Aged Brass Finish, Optional Black Overcoat, MR16 Socket (Lamp Not Included), 2.75" PVC Installation Sleeve, Double Wire Lead (18" & 25')

To add optional finish or lamp, add the suffix noted to the base part number. Example: GL160-BLK-LED4W for a GL160 with a black overcoat and a 4W lamp. For additional beam angles see the lamps page 47

Part #	Price \$	With LED Module	Finish Options	Price \$
GL160-bt	272.92	Integrated bt Module (Bluetooth RGBW)	Standard (Aged Brass)	+0.00
			-BLK (Black Overcoat)	+0.00

Description: In-Ground Light, Cast Brass, Grated Lid with Convex Lens, Aged Brass Finish, Optional Black Overcoat, Integrated bt Module, 2.75" PVC Installation Sleeve, Double Wire Lead (18" & 25')

To add optional finish, add the suffix noted to the base part number. Example: GL160-BT-BLK for a GL160-BT with a black overcoat.

GL170

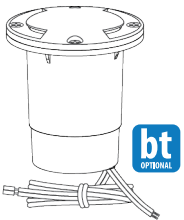

Part #	With No Lamp	Price \$	Finish Options	Price \$	With MR16 Lamp	Price \$
GL170		167.82	Standard (Aged Brass)	+0.00	-LED4W (250lm)	199.20
			-BLK (Black Overcoat)	+0.00	-LED5W (310lm)	
					-LED6W (410lm)	206.41

Description: In-Ground Light, Cast Brass, Opposing Sides Lid with Flat Lens, Aged Brass Finish, Optional Black Overcoat, MR16 Socket (Lamp Not Included), 2.75" PVC Installation Sleeve, Double Wire Lead (18" & 25')

To add optional finish or lamp, add the suffix noted to the base part number. Example: GL170-BLK-LED4W for a GL170 with a black overcoat and a 4W lamp. For additional beam angles see the lamps page 47.

Part #	Price \$	With LED Module	Finish Options	Price \$
GL170-bt	272.92	Integrated bt Module (Bluetooth RGBW)	Standard (Aged Brass)	+0.00
			-BLK (Black Overcoat)	+0.00

Description: In-Ground Light, Cast Brass, Opposing Sides Lid with Flat Lens, Aged Brass Finish, Optional Black Overcoat, Integrated bt Module, 2.75" PVC Installation Sleeve, Double Wire Lead (18" & 25')

To add optional finish, add the suffix noted to the base part number. Example: GL170-BT-BLK for a GL170-BT with a black overcoat.

GL180

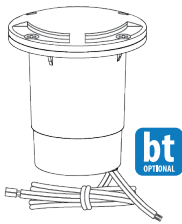

Part #	With No Lamp	Price \$	Finish Options	Price \$	With MR16 Lamp	Price \$
GL180		167.82	Standard (Aged Brass)	+0.00	-LED4W (250lm)	199.20
			-BLK (Black Overcoat)	+0.00	-LED5W (310lm)	
					-LED6W (410lm)	206.41

Description: In-Ground Light, Cast Brass, 180° Output Lid With Flat Lens, Aged Brass Finish, Optional Black Overcoat, MR16 Socket (Lamp Not Included), 2.75" PVC Installation Sleeve, Double Wire Lead (18" & 25')

To add optional finish or lamp, add the suffix noted to the base part number. Example: GL180-BLK-LED4W for a GL180 with a black overcoat and a 4W lamp. For additional beam angles see the lamps page 47.

Part #	Price \$	With LED Module	Finish Options	Price \$
GL180-bt	272.92	Integrated bt Module (Bluetooth RGBW)	Standard (Aged Brass)	+0.00
			-BLK (Black Overcoat)	+0.00

Description: In-Ground Light, Cast Brass, 180° Output Lid With Flat Lens, Aged Brass Finish, Optional Black Overcoat, Integrated bt Module, 2.75" PVC Installation Sleeve, Double Wire Lead (18" & 25')

To add optional finish, add the suffix noted to the base part number. Example: GL180-BT-BLK for a GL180-BT with a black overcoat.

GL190

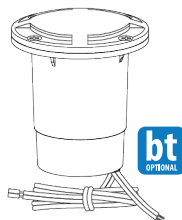

Part #	With No Lamp	Price \$	Finish Options	Price \$	With MR16 Lamp	Price \$
GL190		167.82	Standard (Aged Brass)	+0.00	-LED4W (250lm)	199.20
			-BLK (Black Overcoat)	+0.00	-LED5W (310lm)	
					-LED6W (410lm)	206.41

Description: In-Ground Light, Cast Brass, 360 Output Lid with Flat Lens, Aged Brass Finish, Optional Black Overcoat, MR16 Socket (Lamp Not Included), 2.75" PVC Installation Sleeve, Double Wire Lead (18" & 25')

To add optional finish or lamp, add the suffix noted to the base part number. Example: GL190-BLK-LED4W for a GL190 with a black overcoat and a 4W lamp. For additional beam angles see the lamps page 47.

Part #	Price \$	With LED Module	Finish Options	Price \$
GL190-bt	272.92	Integrated bt Module (Bluetooth RGBW)	Standard (Aged Brass)	+0.00
			-BLK (Black Overcoat)	+0.00

Description: In-Ground Light, Cast Brass, 360 Output Lid with Flat Lens, Aged Brass Finish, Optional Black Overcoat, Integrated bt Module, 2.75" PVC Installation Sleeve, Double Wire Lead (18" & 25')

To add optional finish, add the suffix noted to the base part number. Example: GL190-BT-BLK for a GL190-BT with a black overcoat.

IN-GROUND

GL300

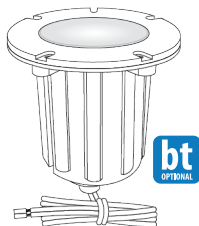

Part #	With No Lamp	Price \$	Finish Options	Price \$	With MR16 Lamp	Price \$
GL300		97.34	Standard (Aged Brass)	+0.00	-LED4W (250lm)	128.72
			-BLK (Black Overcoat)	+0.00	-LED5W (310lm)	
					-LED6W (410lm)	135.93

Description: In-Ground Light, ABS Composite Body, Cast Brass Flat Lid, Aged Brass Finish, Optional Black Overcoat, MR16 Socket (Lamp Not Included), Wire Lead (60")

To add optional finish or lamp, add the suffix noted to the base part number. Example: GL300-BLK-LED4W for a GL300 with a black overcoat and a 4W lamp. For additional beam angles see the lamps page 47.

Part #	Price \$	With LED Module	Finish Options	Price \$
GL300-bt	228.73	Integrated bt Module (Bluetooth RGBW)	Standard (Aged Brass)	+0.00
			-BLK (Black Overcoat)	+0.00

Description: In-Ground Light, ABS Composite Body, Cast Brass Flat Lid, Aged Brass Finish, Optional Black Overcoat, Integrated bt Module, Wire Lead (60")

To add optional finish, add the suffix noted to the base part number. Example: GL300-BT-BLK for a GL300-BT with a black overcoat.

GL310

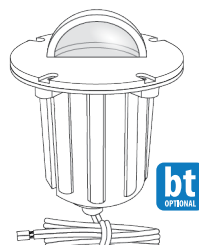

Part #	With No Lamp	Price \$	Finish Options	Price \$	With MR16 Lamp	Price \$
GL310		134.21	Standard (Aged Brass)	+0.00	-LED4W (250lm)	165.59
			-BLK (Black Overcoat)	+0.00	-LED5W (310lm)	
					-LED6W (410lm)	172.80

Description: In-Ground Light, Cast Brass 360 Pattern, ABS Composite Body, Aged Brass Finish, Optional Black Overcoat, MR16 Socket (Lamp Not Included), Wire Lead (60")

To add optional finish or lamp, add the suffix noted to the base part number. Example: GL310-BLK-LED4W for a GL310 with a black overcoat and a 4W lamp. For additional beam angles see the lamps page 47.

Part #	Price \$	With LED Module	Finish Options	Price \$
GL310-bt	265.61	Integrated bt Module (Bluetooth RGBW)	Standard (Aged Brass)	+0.00
			-BLK (Black Overcoat)	+0.00

Description: In-Ground Light, ABS Composite Body, Cast Brass Domed Lid, Aged Brass Finish, Optional Black Overcoat, Integrated bt Module, Wire Lead (60")

To add optional finish, add the suffix noted to the base part number. Example: GL310-BT-BLK for a GL310-BT with a black overcoat.

GL350

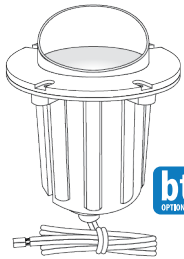

Part #	With No Lamp	Price \$	Finish Options	Price \$	With MR16 Lamp	Price \$
GL350		124.47	Standard (Aged Brass)	+0.00	-LED4W (250lm)	155.85
			-BLK (Black Overcoat)	+0.00	-LED5W (310lm)	
					-LED6W (410lm)	163.06

Description: In-Ground Light, ABS Composite Body, Cast Brass Shrouded Lid with Clear Lens, Aged Brass Finish, Optional Black Overcoat, MR16 Socket (Lamp Not Included), Wire Lead (60")

To add optional finish or lamp, add the suffix noted to the base part number. Example: GL350-BLK-LED4W for a GL350 with a black overcoat and a 4W lamp. For additional beam angles see the lamps page 47.

Part #	Price \$	With LED Module	Finish Options	Price \$
GL350-bt	255.86	Integrated bt Module (Bluetooth RGBW)	Standard (Aged Brass)	+0.00
			-BLK (Black Overcoat)	+0.00

Description: In-Ground Light, ABS Composite Body, Cast Brass Shrouded Lid with Clear Lens, Aged Brass Finish, Optional Black Overcoat, Integrated bt Module, Wire Lead (60")

To add optional finish, add the suffix noted to the base part number. Example: GL350-BT-BLK for a GL350-BT in black overcoat.

GL360

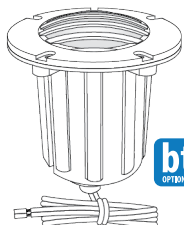

Part #	With No Lamp	Price \$	Finish Options	Price \$	With MR16 Lamp	Price \$
GL360		124.47	Standard (Aged Brass)	+0.00	-LED4W (250lm)	155.85
			-BLK (Black Overcoat)	+0.00	-LED5W (310lm)	
					-LED6W (410lm)	163.06

Description: In-Ground Light, ABS Composite Body, Cast Brass Grated Lid with Clear Lens, Aged Brass Finish, Optional Black Overcoat, MR16 Socket (Lamp Not Included), Wire Lead (60")

To add optional finish or lamp, add the suffix noted to the base part number. Example: GL360-BLK-LED4W for a GL360 with a black overcoat and a 4W lamp. For additional beam angles see the lamps page 47.

Part #	Price \$	With LED Module	Finish Options	Price \$
GL360-bt	255.86	Integrated bt Module (Bluetooth RGBW)	Standard (Aged Brass)	+0.00
			-BLK (Black Overcoat)	+0.00

Description: In-Ground Light, ABS Composite Body, Cast Brass Grated Lid with Clear Lens, Aged Brass Finish, Optional Black Overcoat, Integrated bt Module, Wire Lead (60")

To add optional finish, add the suffix noted to the base part number. Example: GL360-BT-BLK for a GL360-BT in black overcoat.

IN-GROUND

GL370

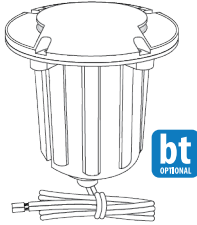

Part #	With No Lamp	Price \$	Finish Options	Price \$	With MR16 Lamp	Price \$
GL370		124.47	Standard (Aged Brass)	+0.00	-LED4W (250lm)	155.85
			-BLK (Black Overcoat)	+0.00	-LED5W (310lm)	
					-LED6W (410lm)	163.06

Description: In-Ground Light, ABS Composite Body, Cast Brass Opposing Sides Lid with Clear Lens, Aged Brass Finish, Optional Black Overcoat, MR16 Socket (Lamp Not Included), Wire Lead (60")

To add optional finish or lamp, add the suffix noted to the base part number. Example: GL370-BLK-LED4W for a GL370 with a black overcoat and a 4W lamp. For additional beam angles see the lamps page 47.

Part #	Price \$	With LED Module	Finish Options	Price \$
GL370-bt	255.86	Integrated bt Module (Bluetooth RGBW)	Standard (Aged Brass)	+0.00
			-BLK (Black Overcoat)	+0.00

Description: In-Ground Light, ABS Composite Body, Cast Brass Opposing Sides Lid with Clear Lens, Aged Brass Finish, Optional Black Overcoat, Integrated bt Module, Wire Lead (60")

To add optional finish, add the suffix noted to the base part number. Example: GL370-BT-BLK for a GL370-BT in black overcoat.

GL380

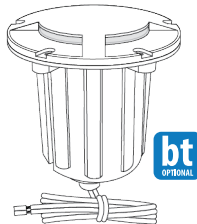

Part #	With No Lamp	Price \$	Finish Options	Price \$	With MR16 Lamp	Price \$
GL380		124.47	Standard (Aged Brass)	+0.00	-LED4W (250lm)	155.85
			-BLK (Black Overcoat)	+0.00	-LED5W (310lm)	
					-LED6W (410lm)	163.06

Description: In-Ground Light, ABS Composite Body, Cast Brass 180 Output with Clear Lens, Aged Brass Finish, Optional Black Overcoat, MR16 Socket (Lamp Not Included), Wire Lead (60")

To add optional finish or lamp, add the suffix noted to the base part number. Example: GL380-BLK-LED4W for a GL380 with a black overcoat and a 4W lamp. For additional beam angles see the lamps page 47.

Part #	Price \$	With LED Module	Finish Options	Price \$
GL380-bt	255.86	Integrated bt Module (Bluetooth RGBW)	Standard (Aged Brass)	+0.00
			-BLK (Black Overcoat)	+0.00

Description: In-Ground Light, ABS Composite Body, Cast Brass 180 Output with Clear Lens, Aged Brass Finish, Optional Black Overcoat, Integrated bt Module, Wire Lead (60")

To add optional finish, add the suffix noted to the base part number. Example: GL380-BT-BLK for a GL380-BT in black overcoat.

GL390

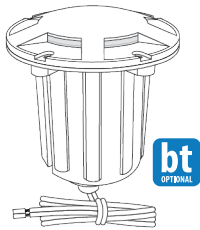

Part #	With No Lamp	Price \$	Finish Options	Price \$	With MR16 Lamp	Price \$
GL390		124.47	Standard (Aged Brass)	+0.00	-LED4W (250lm)	155.85
			-BLK (Black Overcoat)	+0.00	-LED5W (310lm)	
					-LED6W (410lm)	163.06

Description: In-Ground Light, ABS Composite Body, Cast Brass 360 Pattern, Aged Brass Finish, Optional Black Overcoat, MR16 Socket (Lamp Not Included), Wire Lead (60")

To add optional finish or lamp, add the suffix noted to the base part number. Example: GL390-BLK-LED4W for a GL390 with a black overcoat and a 4W lamp. For additional beam angles see the lamps page 47.

Part #	Price \$	With LED Module	Finish Options	Price \$
GL390-bt	255.86	Integrated bt Module (Bluetooth RGBW)	Standard (Aged Brass)	+0.00
			-BLK (Black Overcoat)	+0.00

Description: In-Ground Light, ABS Composite Body, Cast Brass 360 Pattern, Aged Brass Finish, Optional Black Overcoat, Integrated bt Module, Wire Lead (60")

To add optional finish, add the suffix noted to the base part number. Example: GL390-BT-BLK for a GL390-BT in black overcoat.

GL100-TOP

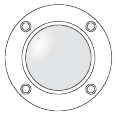

Part #	Finish Options	Price \$
GL100-TOP	Standard (Aged Brass)	16.54
	-BLK (Black Overcoat)	

In-Ground Light Top, Cast Brass Shrouded Open Convex Lens, Aged Brass Finish, Optional Black Overcoat

GL150-TOP

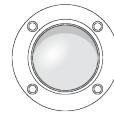

Part #	Finish Options	Price \$
GL150-TOP	Standard (Aged Brass)	16.54
	-BLK (Black Overcoat)	

In-Ground Light Top, Cast Brass Flat Lid and Body, Aged Brass Finish, Optional Black Overcoat

GL160-TOP

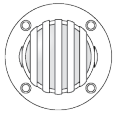

Part #	Finish Options	Price \$
GL160-TOP	Standard (Aged Brass)	33.60
	-BLK (Black Overcoat)	

In-Ground Light Top, Cast Brass Grate-Protected Convex Lens, Aged Brass Finish, Optional Black Overcoat

GL170-TOP

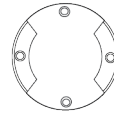

Part #	Finish Options	Price \$
GL170-TOP	Standard (Aged Brass)	33.60
	-BLK (Black Overcoat)	

In-Ground Light Top, Cast Brass Opposing Sides, Aged Brass Finish, Optional Black Overcoat

GL180-TOP

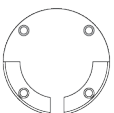

Part #	Finish Options	Price \$
GL180-TOP	Standard (Aged Brass)	33.60
	-BLK (Black Overcoat)	

In-Ground Light Top, Cast Brass 180° Pattern, Aged Brass Finish, Optional Black Overcoat

GL190-TOP

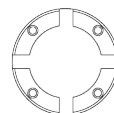

Part #	Finish Options	Price \$
GL190-TOP	Standard (Aged Brass)	33.60
	-BLK (Black Overcoat)	

In-Ground Light Top, Cast Brass 360° Pattern, Aged Brass Finish, Optional Black Overcoat

To add optional finish, add the suffix noted to the base part number. Example: GL190-TOP-BLK for a black overcoat top.

IN-GROUND

GL300-TOP

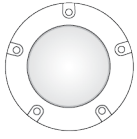

Part #	Finish Options	Price \$
GL300-TOP	Standard (Aged Brass)	27.11
	-BLK (Black Overcoat)	

In-Ground Light Top, Cast Brass Flat Lid, Aged Brass Finish, Optional Black Overcoat

GL310-TOP

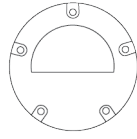

Part #	Finish Options	Price \$
GL310-TOP	Standard (Aged Brass)	63.99
	-BLK (Black Overcoat)	

In-Ground Light Top, Cast Brass Domed Half Lid, Aged Brass Finish, Optional Black Overcoat

GL350-TOP

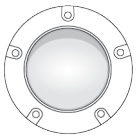

Part #	Finish Options	Price \$
GL350-TOP	Standard (Aged Brass)	54.24
	-BLK (Black Overcoat)	

In-Ground Light Top, Cast Brass Shrouded Open Convex Lens, Aged Brass Finish, Optional Black Overcoat

GL360-TOP

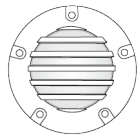

Part #	Finish Options	Price \$
GL360-TOP	Standard (Aged Brass)	54.24
	-BLK (Black Overcoat)	

In-Ground Light Top, Cast Brass Grate-Protected Convex Lens, Aged Brass Finish, Optional Black Overcoat

GL370-TOP

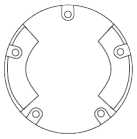

Part #	Finish Options	Price \$
GL370-TOP	Standard (Aged Brass)	54.24
	-BLK (Black Overcoat)	

In-Ground Light Top, Cast Brass Opposing Sides, Aged Brass Finish, Optional Black Overcoat

GL380-TOP

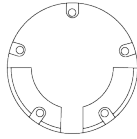

Part #	Finish Options	Price \$
GL380-TOP	Standard (Aged Brass)	54.24
	-BLK (Black Overcoat)	

In-Ground Light Top, Cast Brass 180° Pattern, Aged Brass Finish, Optional Black Overcoat

GL390-TOP

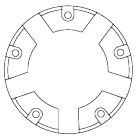

Part #	Finish Options	Price \$
GL390-TOP	Standard (Aged Brass)	54.24
	-BLK (Black Overcoat)	

In-Ground Light Top, Cast Brass 360° Pattern, Aged Brass Finish, Optional Black Overcoat

To add optional finish, add the suffix noted to the base part number. Example: GL390-TOP-BLK for black overcoat top.

SL100



Part #	With No Lamp	Price \$	Finish Options	Price \$	With G4 Lamp	Price \$
SL100		99.21	Standard (Aged Brass)	+0.00	-LED (200lm)	124.32
			-BLK (Black Overcoat)	+0.00		

Description: Hardscape Light, Cast Brass, 3.4" Diameter, Aged Brass Finish, Optional Black Overcoat, G4 Bi-Pin Socket (Lamp Not Included), Mounting Base Plate, Wire Lead (25')

To add optional finish or lamp, add the suffixes noted to the base part number. Example: SL100-BLK-LED for a SL100 in black overcoat with the LBIPIN-LED-200lm lamp included.

SL150



Part #	With No Lamp	Price \$	Finish Options	Price \$	With G4 Lamp	Price \$
SL150		88.97	Standard (Aged Brass)	+0.00	-LED (200lm)	114.08
			-BLK (Black Overcoat)	+0.00		

Description: Hardscape Light, Brass, 3.9" Width, Aged Brass Finish, Optional Black Overcoat, G4 Bi-Pin Socket (Lamp Not Included), Mounting Base Plate, Wire Lead (25')

To add optional lamp, add the suffixes noted to the base part number. Example: SL150-LED for a SL150 with the LBIPIN-LED-200lm lamp included.

SL25-LED

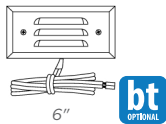

Part #	Price \$	With LED Module	Finish Options	Price \$
SL25-LED	127.44	Integrated LED Module (2700k)	Standard (Aged Brass)	+0.00
			-BLK (Black Overcoat)	+0.00

Description: Step Light, Brass Louvered Face Plate, 6" Width, Aged Brass Finish, Optional Black Overcoat, Integrated LED Module, Surface Mounted, Wire Lead (25')

To add optional finish, add the suffixes noted to the base part number. Example: SL25-LED-BLK for a SL25-LED in black overcoat.

Part #	Price \$	With LED Module	Finish Options	Price \$
SL25-bt	232.28	Integrated bt Module (Bluetooth RGBW)	Standard (Aged Brass)	+0.00
			-BLK (Black Overcoat)	+0.00

Description: Step Light, Brass Louvered Face Plate, 6" Width, Aged Brass Finish, Optional Black Overcoat, Integrated bt Module, Surface Mounted, Wire Lead (25')

SL35-LED

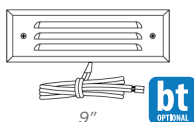

Part #	Price \$	With LED Module	Finish Options	Price \$
SL35-LED	166.51	Integrated LED Module (2700k)	Standard (Aged Brass)	+0.00
			-BLK (Black Overcoat)	+0.00

Description: Step Light, Brass Louvered Face Plate, 9" Width, Aged Brass Finish, Optional Black Overcoat, Integrated LED Module, Surface Mounted, Wire Lead (25')

To add optional finish, add the suffixes noted to the base part number. Example: SL35-LED-BLK for a SL35-LED in black overcoat.

Part #	Price \$	With LED Module	Finish Options	Price \$
SL35-bt	272.92	Integrated bt Module (Bluetooth RGBW)	Standard (Aged Brass)	+0.00
			-BLK (Black Overcoat)	+0.00

Description: Step Light, Brass Louvered Face Plate, 9" Width, Aged Brass Finish, Optional Black Overcoat, Integrated bt Module, Surface Mounted, Wire Lead (25')

SL26-LED

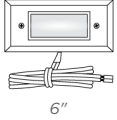

Part #	Price \$	With LED Module	Finish Options	Price \$
SL26-LED	127.44	Integrated LED Module (2700k)	Standard (Aged Brass)	+0.00
			-BLK (Black Overcoat)	+0.00

Description: Step Light, Brass Frosted Face Plate, 6" Width, Aged Brass Finish, Optional Black Overcoat, Integrated LED Module, Surface Mounted, Wire Lead (25')

To add optional finish, add the suffixes noted to the base part number. Example: SL26-LED-BLK for a SL26-LED in black overcoat.

SL36-LED

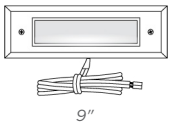

Part #	Price \$	With LED Module	Finish Options	Price \$
SL36-LED	166.51	Integrated LED Module (2700k)	Standard (Aged Brass)	+0.00
			-BLK (Black Overcoat)	+0.00

Description: Step Light, Brass Frosted Face Plate, 9" Width, Aged Brass Finish, Optional Black Overcoat, Integrated LED Module, Surface Mounted, Wire Lead (25')

To add optional finish, add the suffixes noted to the base part number. Example: SL36-LED-BLK for a SL36-LED in black overcoat.

SL65-LED

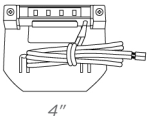

Part #	Price \$	With LED Module	Finish Options	Price \$
SL65-LED	88.37	Integrated LED Module (110lm)	Standard (Aged Brass)	+0.00
			-BLK (Black Overcoat)	+0.00

Description: Ledge Light, Cast Brass Housing, 4" Width, Aged Brass Finish, Optional Black Overcoat, Integrated LED Module, Removable Mounting Plate, Wire Lead (10')

To add optional finish, add the suffixes noted to the base part number. Example: SL65-LED-BLK for a SL65-LED in black overcoat.

SL75-LED

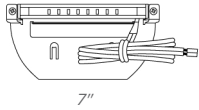

Part #	Price \$	With LED Module	Finish Options	Price \$
SL75-LED	104.37	Integrated LED Module (300lm)	Standard (Aged Brass)	+0.00
			-BLK (Black Overcoat)	+0.00

Description: Ledge Light, Cast Brass Housing, 7" Width, Aged Brass Finish, Optional Black Overcoat, Integrated LED Module, Removable Mounting Plate, Wire Lead (10')

To add optional finish, add the suffixes noted to the base part number. Example: SL75-LED-BLK for a SL75-LED in black overcoat.

SL85-LED

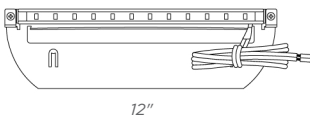

Part #	Price \$	With LED Module	Finish Options	Price \$
SL85-LED	169.93	Integrated LED Module (380lm)	Standard (Aged Brass)	+0.00
			-BLK (Black Overcoat)	+0.00

Description: Ledge Light, Cast Brass Housing, 12" Width, Aged Brass Finish, Optional Black Overcoat, Integrated LED Module, Removable Mounting Plate, Wire Lead (10')

SL60-bt



5"



Part #	Price \$	With LED Module	Finish Options	Price \$
SL60-bt	185.41	Integrated bt Module (Bluetooth RGBW)	Standard (Aged Brass)	+0.00
			-BLK (Black Overcoat)	+0.00

Description: Ledge Light, Brass Body, 5" Width, Aged Brass Finish, Optional Black Overcoat, Integrated bt Module, Surface Mounted, Wire Lead (25')

To add optional finish, add the suffix noted to the base part number. Example: SL60-BT-BLK for a SL60-BT in black overcoat.

SL70

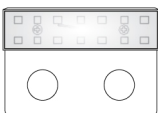

5"



Part #	With No Lamp	Price \$	Finish Options	Price \$	With G4 Lamp	Price \$
SL70		82.37	Standard (Aged Brass)	+0.00	-LED (200lm)	107.48
			-BLK (Black Overcoat)	+0.00		

Description: Step Light, Brass Body and Flange, 5" Width, Aged Brass Finish, Optional Black Overcoat, G4 Bi-Pin Socket (Lamp Not Included), Mounting Plate, Wire Lead (25')

To add optional lamp, add the suffix noted to the base part number. Example: SL70-BLK for a SL70 in black overcoat.

Part #	Price \$	With LED Module	Finish Options	Price \$
SL70-bt	185.41	Integrated bt Module (Bluetooth RGBW)	Standard (Aged Brass)	+0.00
			-BLK (Black Overcoat)	+0.00

Description: Step Light, Brass Body and Flange, 5" Width, Aged Brass Finish, Optional Black Overcoat, Integrated bt Module, Mounting Plate, Wire Lead (25')

SL80-bt

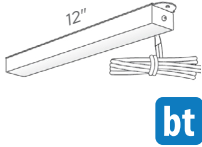

Part #	Price \$	With LED Module	Finish Options	Price \$
SL80-bt	237.23	Integrated bt Module (Bluetooth RGBW)	Standard (Aged Brass)	+0.00
			-BLK (Black Overcoat)	+0.00

Description: Ledge Light, Brass Body, 5" Width, Aged Brass Finish, Optional Black Overcoat, Integrated bt Module, Surface Mounted, Wire Lead (25')

To add optional finish, add the suffix noted to the base part number. Example: SL80-BT-BLK for a SL60-BT in black overcoat.

POST50

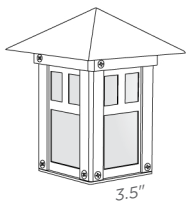

Part #	With No Lamp	Price \$	Finish	Price \$	With G4 Lamp	Price \$
POST50		122.20	Standard (Aged Brass)	+0.00	-LED (200lm)	147.31
			-BLK (Black Overcoat)	+0.00		

Description: Post Light, Brass, Aged Brass Finish, Optional Black Overcoat, G4 Bi-Pin Socket (Lamp Not Included), Mounting Base Plate, 3.5" Width, Wire Lead (25')

To add optional lamp, add the suffixes noted to the base part number. Example: POST50-LED for a POST50 with the LBIPIN-LED-200lm lamp included.

POST100

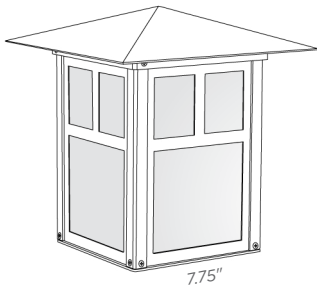

Part #	With No Lamp	Price \$	Finish	Price \$	With MR16 Lamp	Price \$
POST100		596.53	Standard (Aged Brass)	+0.00	-LED4W (250lm)	627.91
			-BLK (Black Overcoat)	+0.00	-LED5W (310lm)	
					-LED6W (410lm)	635.12

Description: Post Light, Brass, Aged Brass Finish, Optional Black Overcoat, MR16 Socket (Lamp Not Included), Mounting Base Plate, 7.75" Width, Wire Lead (25')

To add optional lamp, add the suffix noted to the base part number. Example: POST100-LED4W for a POST100 with a 4W lamp. For additional beam angles see the lamps page 47.

TAPE



Part #	Price \$	Product Length	Lumens
TAPE-LED-5FT	82.96	5'	350
TAPE-LED-15FT	248.89	15'	1,050
TAPE-LED-30FT	497.74	30'	2,100

Description: Hardscape LED Strip, Integrated LED Emitters, Surface Mounted, Wire Lead (10').

Part #	Price \$	Product Length	With LED Module
TAPE-BT-5FT	103.81	5'	Integrated bt Module (Bluetooth RGBW)
TAPE-BT-15FT	311.42	15'	Integrated bt Module (Bluetooth RGBW)

Hardscape LED Strip, Integrated LED Emitters, Surface Mounted, Wire Lead (10'). Bt Control Box Included. Conceal bt Control Box During installation.



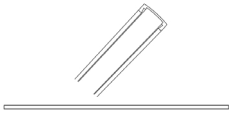

Part #	Price \$	Product Length	Construction
TAPE-SLV-3	6.86	3'	Aluminum

Description: Hardscape Accessory, Aluminum Tape Sleeve (3'), Mounted Directly to Surface, Frosted Lens Included

WS350-bt

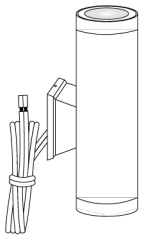

Part #	Price \$	With LED Module	Finish Options	Price \$
WS350-bt	299.25	Integrated bt Module (Bluetooth RGBW)	Standard (Aged Brass)	+0.00
			-BLK (Black Overcoat)	+0.00
			-WHT (White Overcoat)	+0.00

Description: Wall Sconce Light, Cast Brass, Aged Brass Finish, Optional Black Overcoat, Integrated bt Module, Wire Lead (25')

To add optional finish, add the suffixes noted to the base part number. Example: WS350-BT-WHT for a WS350-BT in white overcoat.

SPECIALTY

UL100

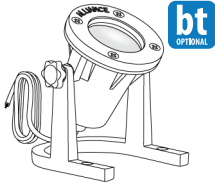

Part #	With No Lamp	Price \$	Finish	Price \$	With MR16 Lamp	Price \$
UL100		223.07	Standard (Aged Brass)	+0.00	-LED4W (250lm) -LED5W (310lm)	254.45
					-LED6W (410lm)	261.66

Description: Underwater Light, Solid Cast Brass, Aged Brass Finish, MR16 Socket (Lamp Not Included), Heavy Brass Base, Waterproof Wire Lead (25')

To add optional lamp, add the suffix noted to the base part number. Example: UL100-LED4W for a UL100 with a 4W lamp. For additional beam angles see the lamps page 47.

Part #	With No Lamp	Price \$	Finish	Price \$	With MR16 Lamp	Price \$
UL100-50FT		254.42	Standard (Aged Brass)	+0.00	-LED4W (250lm) -LED5W (310lm)	285.80
					-LED6W (410lm)	293.01

Description: Underwater Light, Solid Cast Brass, Aged Brass Finish, MR16 Socket (Lamp Not Included), Heavy Brass Base, Waterproof Wire Lead (50')

Part #	Price \$	With LED Module	Finish	Price \$
UL100-bt	331.73	Integrated bt Module (Bluetooth RGBW)	Standard (Aged Brass)	+0.00

Description: Underwater Light, Solid Cast Brass, Aged Brass Finish, Integrated bt Module, Heavy Brass Base, Waterproof Wire Lead (25')

UL395-LED

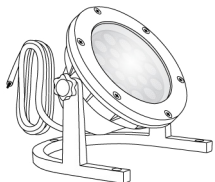

Part #	Price \$	With LED Module	Finish	Price \$
UL395-LED	330.75	Integrated 1,200 Lumen LED Module (3000k)	Standard (Aged Brass)	+0.00

Description: Underwater Light, Solid Cast Brass, Aged Brass Finish, Integrated 1200 Lumen LED Included, Heavy Brass Base, Waterproof Wire Lead (25')

ML15-LED

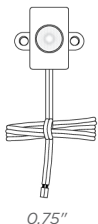

Part #	Price \$	With LED Module	Finish Options	Price \$
ML15-LED	48.37	Integrated LED Module (2900k)	Standard (Aged Brass)	+0.00
			-BLK (Black Overcoat)	+0.00

Description: Mini Light, Cast Brass, 0.75" Width, Aged Brass Finish, Optional Black Overcoat, Integrated LED Module, 6" Stainless Steel Stake, Wire Lead (10')

To add optional finish, add the suffixes noted to the base part number. Example: ML15-LED-BLK for a ML15-LED in black overcoat.

ML25-LED

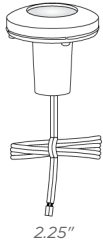

2.25"

Part #	Price \$	With LED Module	Finish Options	Price \$
ML25-LED	55.61	Integrated LED Module (2900k)	Standard (Aged Brass)	+0.00
			-BLK (Black Overcoat)	+0.00

Description: Mini Light, Cast Brass, 2.25" Width, Aged Brass Finish, Optional Black Overcoat, Integrated LED Module, 1" PVC Installation Sleeve, Wire Lead (10')

To add optional finish, add the suffixes noted to the base part number. Example: ML25-LED-BLK for a ML25-LED in black overcoat.

ML35-LED



2.5"

Part #	Price \$	With LED Module	Finish Options	Price \$
ML35-LED	57.53	Integrated LED Module (2900k)	Standard (Aged Brass)	+0.00
			-BLK (Black Overcoat)	+0.00

Description: Mini Wall Mount Light, Cast Brass, 2.5" Width, Aged Brass Finish, Optional Black Overcoat, Integrated LED Module, Wall Plate, Wire Lead (10')

To add optional finish, add the suffixes noted to the base part number. Example: ML35-LED-BLK for a ML35-LED in black overcoat.

ML45-LED

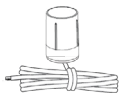

0.9"

Part #	Price \$	With LED Module	Finish Options	Price \$
ML55-LED	49.38	Integrated LED Module (2900k)	None	+0.00

Description: Mini Marker Light, ___Construction, 0.9 Width, Integrated LED Module, Wire Lead (10')

ML55-LED

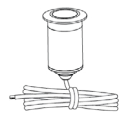

1.1"

Part #	Price \$	With LED Module	Finish Options	Price \$
ML55-LED	49.38	Integrated LED Module (2900k)	Standard (Aged Brass)	+0.00
			-BLK (Black Overcoat)	+0.00

Description: Mini Marker Light, Cast Brass, 1.1" Width, Aged Brass Finish, Optional Black Overcoat, Integrated LED Module, Wire Lead (10')

To add optional finish, add the suffixes noted to the base part number. Example: ML55-LED-BLK for a ML55-LED in black overcoat.

ML65

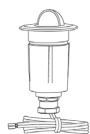

2.875"

Part #	With No Lamp	Price \$	Finish	Price \$	With MR8 Lamp	Price \$
ML65		69.95	Standard (Aged Brass)	+0.00	-LED (150lm)	119.33
			-BLK (Black Overcoat)	+0.00		

Description: Mini Light, Cast Brass, 2.875" Width, Aged Brass Finish, Optional Black Overcoat, 5" Installation Tube, Wire Lead (10')

To add optional finish, add the suffixes noted to the base part number. Example: ML65-LED-BLK for a ML65-LED in black overcoat.

GOLF100

Part #	With No Lamp	Price \$	Finish	Price \$	With G4 Lamp	Price \$
GOLF100		217.06	Standard (Aged Brass)	+0.00	-LED (200lm)	242.17
			-BLK (Black Overcoat)	+0.00		

Description: Specialty Light, Solid Brass, Aged Brass Finish, Optional Black Overcoat, 45 Degree Angled Brass Riser, G4 Bi-Pin Socket (Lamp Not Included), Wire Lead (25')

To add optional lamp, add the suffixes noted to the base part number. Example: GOLF100-LED for a GOLF100 with the LBIPIN-LED-200lm lamp included.

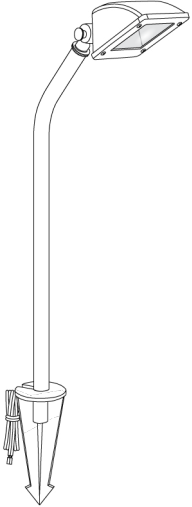

GOLF50-bt

Part #	Price \$	With LED Module	Finish	Price \$
GOLF50-bt	291.87	Integrated bt Module (Bluetooth RGBW)	Standard (Aged Brass)	+0.00
			-BLK (Black Overcoat)	+0.00

Description: Specialty Light, Solid Brass, Aged Brass Finish, Optional Black Overcoat, 45 Degree Angled Brass Riser, Integrated bt Module, Wire Lead (25')

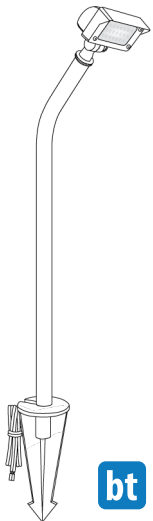

TIKI

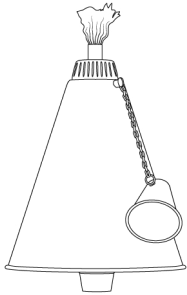

Part #	Price \$	Finish	Type
TIKI	237.36	Standard (Aged Brass)	Area Light Hat
		-BLK (Black Overcoat)	
TIKI-WICK	25.15	N/A	5 Replacement TIKI Wicks

Description: Specialty Area Hat, Brass, Aged Brass Finish, Optional Black Overcoat

Note: TIKI area light hat and ALSTEM60 sold separately.

ALSTEM60

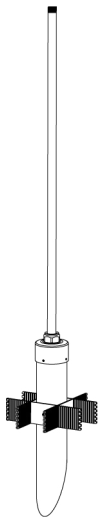

Part #	With No Lamp	Price \$	Finish	Price \$	With G4 Lamp	Price \$
ALSTEM60		261.68	Standard (Aged Brass)	+0.00	-LED (200lm)	286.79
			-BLK (Black Overcoat)	+0.00		

Description: TIKI Light Stem, Cast Brass, Aged Brass Finish, Optional Black Overcoat, G4 Bi-Pin Socket (Lamp Not Included), Permapost Stake, Double Wire Lead (18" & 25')

To add optional lamp, add the suffixes noted to the base part number. Example: ALSTEM60-LED for a ALSTEM60 with the LBIPIN-LED-200lm lamp included.

POWER & CONTROL

IT2-150 IT2-300

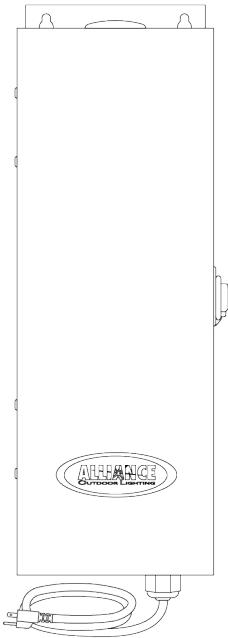

Part #	Price \$	Smart Transformer Power Capacity	Construction
IT2-150	545.73	150 Watts	Heavy Duty Stainless Steel

Description: Intelligent Transformer, 150 Watt, Heavy-Duty Stainless-Steel, 3 Zoned Taps (14v Each), 3 Common Terminals, Grounded Power Cord (5')

Part #	Price \$	Smart Transformer Power Capacity	Construction
IT2-300	619.88	300 Watts	Heavy Duty Stainless Steel

Description: Intelligent Transformer, 300 Watt, Heavy-Duty Stainless-Steel, 3 Zoned Taps (14v Each), 3 Common Terminals, Grounded Power Cord (5')

XF150 XF300 XF600

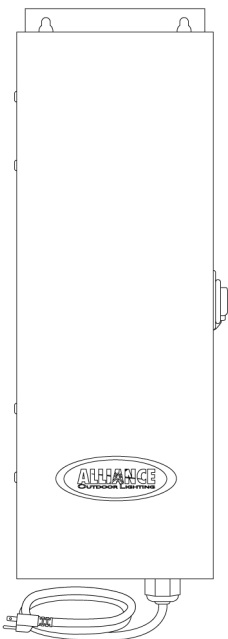

Part #	Price \$	Power Capacity	Construction
XF150	366.41	150 Watts	Heavy Duty Stainless Steel

Description: Transformer, 150 Watt, Heavy-Duty Stainless-Steel, 4 Taps (12v, 13v, 14v, 15v), 1 Common Terminal, Grounded Power Cord (5')

Part #	Price \$	Power Capacity	Construction
XF300	446.83	300 Watts	Heavy Duty Stainless Steel

Description: Transformer, 300 Watt, Heavy-Duty Stainless-Steel, 4 Taps (12v, 13v, 14v, 15v), 2 Common Terminals, Grounded Power Cord (5')

Part #	Price \$	Power Capacity	Construction
XF600	817.72	600 Watts	Heavy Duty Stainless Steel

Description: Transformer, 600 Watt, Heavy-Duty Stainless-Steel, 6 Taps (12v, 13v, 14v, 15v, 16v, 17v, 18v), 2 Common Terminals, Grounded Power Cord (5')

To add iTimerPro and create an XF PRO pack, add the suffix noted to the base part number. Example: XF150PRO for an XF150 with an iTimerPro.

iTimerPro

Part #	Price \$	120 Volt, 15 Amp Outputs	Construction
ITIMERPRO	168.53	1 Output	Black ABS Plastic
ITIMERPRO-DUO	187.96	2 Outputs	Black ABS Plastic

Description: App-Based Timer Control, Indoor / Outdoor Use, Bluetooth-Based, Wall Mounted, Grounded Power Cord (32")



iTimerPro-2

Part #	Price \$	120 Volt, 15 Amp Output	Construction
ITIMERPRO-2	168.53	1 Output	Black ABS Plastic

Description: App-Based Timer Control, Indoor / Outdoor Use, Bluetooth / WiFi-Based, Wall Mounted, Grounded Power Cord (32")



PC

Part #	Price \$	Construction
PC	51.69	Plastic

Photocell, Provides Dusk-to-Dawn Control

Note: This photocell is adapted to fit the Alliance XF series transformers.



TIMER

Part #	Price \$	Construction
TIMER2	36.40	Plastic

Mechanical Timer, Plugs into Outlet in XF Transformer

Note: This TIMER is adapted to fit the Alliance XF series transformers.

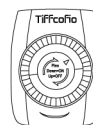

POWER & CONTROL

TF150

Part #	Price \$	Power Capacity	Construction
TF150	138.01	150 Watts	Black ABS Plastic

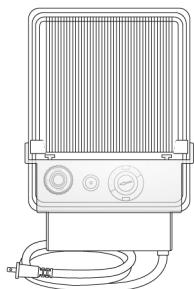

Description: Transformer, 150 Watt, Plastic Housing, Tap (12v), On-Board Photocell and Timer, Grounded Power Cord (5')

TF200 TF300

Part #	Price \$	Power Capacity	Construction
TF200	252.46	200 Watts	Heavy Duty Stainless Steel

Description: Transformer, 200 Watt, Stainless Steel, Tap (12v), On-Board Photocell and Digital Timer, Grounded Power Cord (5')

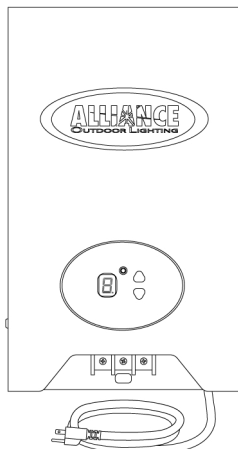

Part #	Price \$	Power Capacity	Construction
TF300	316.60	300 Watts	Heavy Duty Stainless Steel

Description: Transformer, 300 Watt, Stainless Steel, 2 Taps (12v, 14v), 1 Common Terminal, On-Board Photocell and Digital Timer, Grounded Power Cord (5')

CS100 CS150

Part #	Price \$	Parts Included
CS100	21.92	ABS Plastic Cap, PVC Tube, 2 Brass Connectors, & 2 Pre-Greased Plastic Caps
CS150	8.87	2 Brass Connectors, & 2 Pre-Greased Plastic Caps

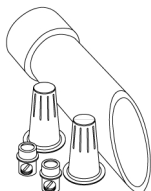

Description: Power & Control Accessory, PVC Housing, Buried Connection Point for Wiring

BTRE

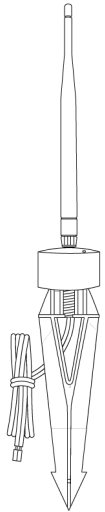

Part #	Price \$	Operating Voltage	Construction
BTRE	51.86	10-14 Volts	Aged Brass Cap
BTRE-5PK	259.26		

Description: bt System Range Extender, Aged Brass Finish, External Antenna, LED Indicator Light, Slotted 8.5" Ground Stake, Wire Lead (5')

BTRE-SM

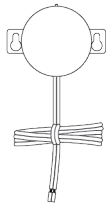

Part #	Price \$	Operating Voltage	Construction
BTRE-SM	51.86	10-14 Volts	Black ABS Plastic

Description: bt System Surface Mounted Range Extender, LED Indicator Light, Mounting Ears for Attachment to Vertical Surfaces, Wire Lead (5')

BTRE-PLUGIN



Part #	Price \$	Operating Voltage	Construction
BTRE-PLUGIN	58.60	120 Volts	White Plastic

Description: bt System Indoor Range Extender, White, LED Indicator Light, 120v Grounded Receptacle

ACCENT / UPLIGHT

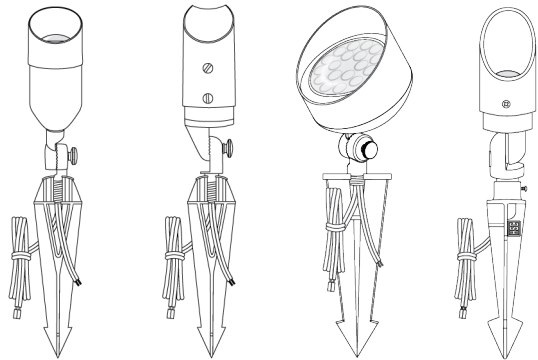

BL200-bt PG 5 **BL900-bt** PG 5 **BL400-bt** PG 6 **HSC-BL3-BT** PG 6

AREA & PATH

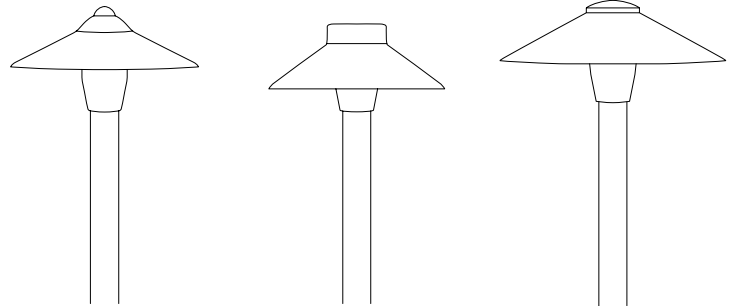

AL100 PG 8-9 **AL150** PG 8-9 **AL250** PG 8-9

AREA & PATH

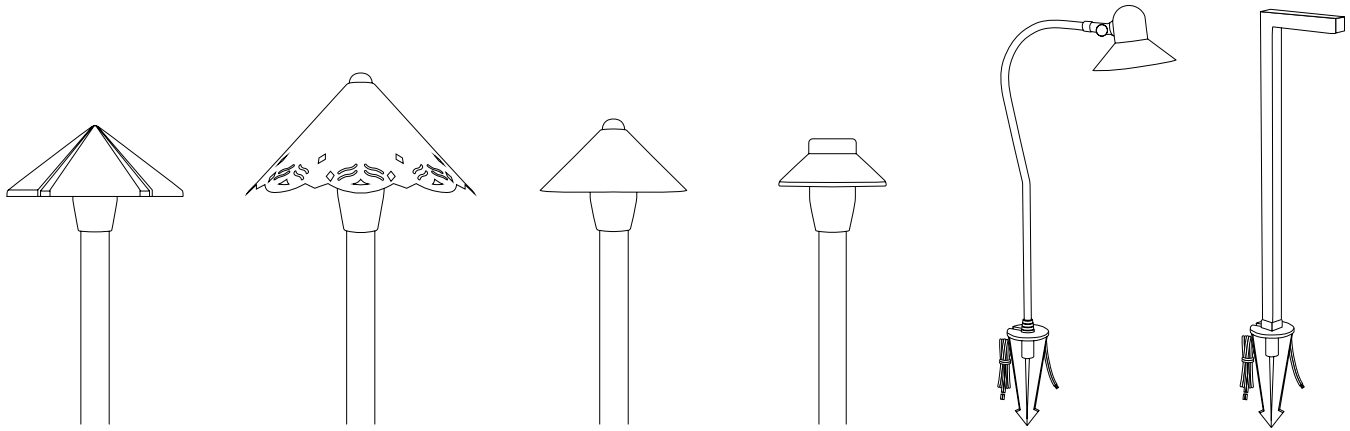

AL300 PG 8-9 **AL400** PG 8-9 **AL500** PG 8-9 **AL550** PG 8-9 **PL100-bt** PG 10 **PL300-bt** PG 7

IN-GROUND

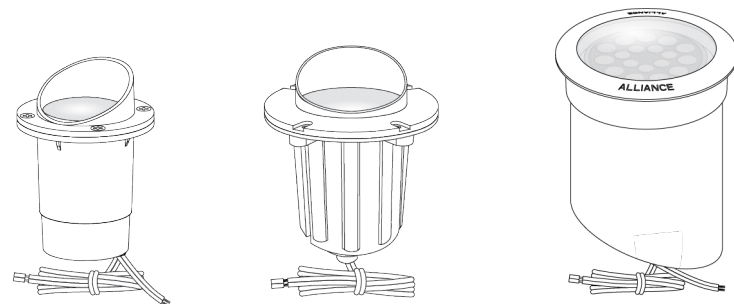

GL100 Series PG 18-20 **GL300 Series** PG 21-24 **WL400-bt** PG 17

WALL WASH

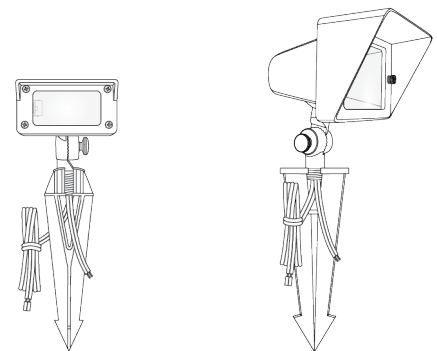

FL50-bt PG 13 **FL200-bt** PG 13

HARDSCAPE

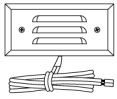

SL25-bt
PG 26

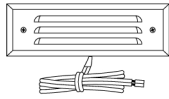

SL35-bt
PG 26



SL60-bt
PG 28

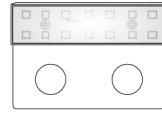

SL70-bt
PG 28

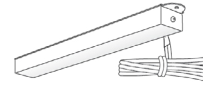

SL80-bt
PG 28

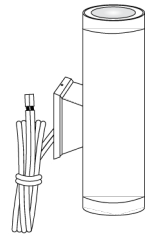

WS350-bt
PG 30

DOWN LIGHTS

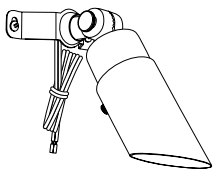

DL200-bt
PG 14



HL100-bt
PG 15



HL200-bt
PG 15

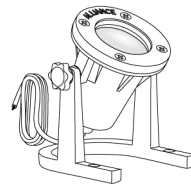

UL100-bt
PG 31

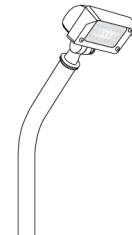

GOLF50-bt
PG 33

SPECIALTY

LAMPS

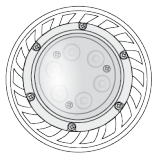

bt-ALLY-PAR36
PG 44



bt-ALLY-MR16
PG 44



bt-ALLY-G4
PG 44



bt-ALLY-A19
PG 44

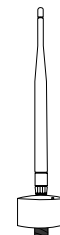

BTRE
PG 37

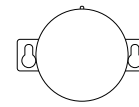

BTRE-SM
PG 37

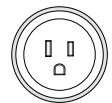

BTRE-PLUGIN
PG 37

BLUETOOTH RANGE EXTENDERS (BTRE)



On board BT system capability is available on a wide selection of Alliance fixtures covering every possible landscape lighting need. Pricing information for each component is on the page noted below the product number.

Scan the QR code to download a copy of our BT System Installation Guide to plan the components needed for any installation.

FIXTURE ACCESSORIES

TREEMOUNT



Part #	Price \$	Construction
TREEMOUNT	38.89	Cast Aluminum

Description: For attaching 1/2" threaded fixture to tree. Includes offset lag screws, nuts and washers Aluminum, Black Overcoat, 1/2" MPT, Junction Box Mount

STAKE

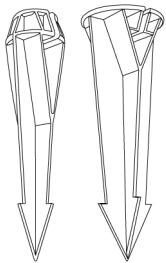

Part #	Price \$	Construction	Size	Color
STAKE-P1	3.70	PVC Plastic	Standard	Standard (Brown)
STAKE-P2	4.97		Large	-BLK (Black)
STAKE-P3	9.90		Jumbo	

Description: Fixture Installation Accessory, Standard 8.5" Plastic Stake, Accepts 1/2" MPT Fixture

PERMAPOST

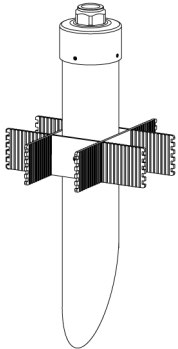

Part #	Price \$	Construction	Finish
PERMAPOST	109.11	Brass Locking Nut & Cap, PVC Plastic Body	Standard (Aged Brass)
			-BLK (Black Overcoat)

Description: Deep Anchoring Permapost Stake, PVC Body, Brass Locking Nut and Cap, Aged Brass Finish, Optional Black Overcoat

RMB

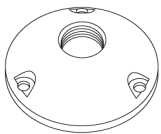

Part #	Price \$	Finish Options
RMB	24.12	Standard (Aged Brass)
		-BLK (Black Overcoat)

Round Mounting Base, Solid Brass, Aged Brass Finish, Optional Black Overcoat, 3", Accepts 1/2" MPT Fixture

GUTTERMOUNT

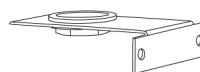

Part #	Price \$	Finish
GUTTERMOUNT	16.00	Standard (Aged Brass)
		-BLK (Black Overcoat)

Mounting Base for Gutters, Solid Brass, Aged Brass Finish, Optional Black Overcoat, 3.3" Length, Accepts 1/2" MPT Fixture

L-ADAPTER

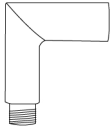

Part #	Price \$	Finish
L-ADAPTER	26.02	Standard (Aged Brass)
		-BLK (Black Overcoat)

Fixture Installation Accessory, Cast Brass, Aged Brass Finish, Optional Black Overcoat, Paired with Riser to create Aimable Area Light, Accepts 1/2" MPT Fixture

T-ADAPTER

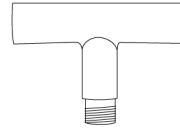

Part #	Price \$	Finish
T-ADAPTER	26.02	Standard (Aged Brass)
		-BLK (Black Overcoat)

Fixture Installation Accessory, Cast Brass, Aged Brass Finish, Optional Black Overcoat, Paired with Riser to create Dual-Head Accent Fixtures, Accepts 1/2" MPT Fixture

A-LOC-50



Part #	Price \$	Quantity	Construction
A-LOC-50	77.52	50 Pieces	Blue ABS Plastic

Description: Locking Waterproof Connector with Crimp Sleeve, Container of 50

RISER6 RISER12 RISER18



Part #	Price \$	Finish Options
RISER6	22.17	Standard (Aged Brass) +0.00
RISER12	33.90	-BLK (Black Overcoat) +0.00
RISER18	43.27	

Description: Fixture Installation Accessory, Solid Brass, Aged Brass Finish, Optional Black Overcoat, Fixed Riser, Accepts 1/2" MPT Fixture

To add optional finish, add the suffixes noted to the base part number. Example: RISER12-BLK for a RISER12 in black overcoat.

FIXTURE ACCESSORIES

CGWL01-GRATE



Part #	Price \$	Finish Options	Price \$
CGWL01-GRATE	88.05	Standard (Aged Brass)	+0.00
		-BLK (Black Overcoat)	+0.00

Description: In-Ground Light Top, Heavy Duty Brass Grated Lid, Aged Brass Finish Optional Black Overcoat

CGWL02-TOP

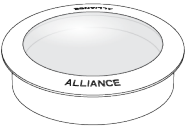

Part #	Price \$	Finish Options	Price \$
CGWL02-TOP	88.05	Standard (Aged Brass)	+0.00
		-BLK (Black Overcoat)	+0.00

Description: In-Ground Light Top, Heavy Duty Brass Lid, Aged Brass Finish, Optional Black Overcoat

HEX LOUVERS

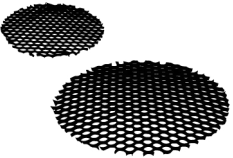

Part #	Price \$	Construction	Color
HEXLOUVER-MR16	4.71	Aluminum	Standard (Black)
HEXLOUVER-PAR36	7.35		

Description: Fixture Installation Accessory, Hex Louver, Aluminum, MR16 / PAR36 size, fits Alliance fixtures using a MR16 lamp / PAR36 lamp.

FROSTED LENS

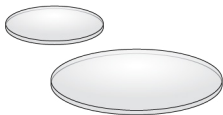

Part #	Price \$	Construction
MR16LENS-FROSTED	3.22	Frosted Flat Glass Lens
PAR36LENS-FROSTED	6.05	

Description: Fixture Installation Accessory, Frosted Lens, Tempered Glass, MR-16 / PAR36 size, fits Alliance fixtures using a MR16 / PAR36 lamp.

DEMOKIT-8

Part #	Price \$	TF150 Transformer	BL200-LED	ALSTEM12-LED	AL100 Hats	Storage Case
DEMOKIT-8	1,392.76	1	6	2	2	1

Description: DEMOKIT, (6) BL200-LED4W, (2) ALSTEM12-LED, (2) AL100, (1) TF150, (2) Wire Splitters, (12) Extra Connectors, Storage Case

DEMOKIT-8-bt

Part #	Price \$	TF150 Transformer	BL200-bt	ALSTEM12-bt	AL100 Hats	BTRE	Storage Case
DEMOKIT-8-bt	2,051.37	1	6	2	2	1	1

Description: DEMOKIT, (6) BL200-BT, (2) ALSTEM12-BT, (2) AL100, (1) BTRE, (1) TF150, (2) Wire Splitters, (12) Extra Connectors, Storage Case

LAMPS

BT-ALLY-MR16



Part #	Price \$	Wattage	Beam Angle	Delivered Lumens	Color Temp.
BT-ALLY-MR16	90.74	2w - 4w	40° Flood	10 - 430 Lumens	Adjustable White 2700K-5000K or RGBW Presets or Custom

Description: MR16 RGBW CCT Lamp, bt System App-Controlled, 40 Degree Flood, 10 - 430 Lumens, 2700K - 4000K, White Base

BT-ALLY-PAR36

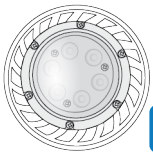

Part #	Price \$	Wattage	Beam Angle	Delivered Lumens	Color Temp.	Base Color
BT-ALLY-PAR36	178.03	2w - 7w	45° Flood	15 - 460 Lumens	Adjustable White 2700K-5000K or RGBW Presets or Custom	Red

Description: PAR36 RGBW CCT Lamp, bt System App-Controlled, 45 Degree Flood, 15 - 460 Lumens, 2700K - 4000K, Red Base

BT-ALLY-G4



Part #	Price \$	Wattage	Beam Angle	Delivered Lumens	Color Temp.	Base Color
BT-ALLY-G4	90.74	1w - 2.5w	360° Flood	10 - 250 Lumens	Adjustable White 2700K-5000K or RGBW Presets or Custom	White

Description: G4 RGBW CCT Lamp, bt System App-Controlled, 360 Degree Flood, 10 - 250 Lumens, 2700K - 4000K, White Base

BT-ALLY-A19



Part #	Price \$	Wattage	Beam Angle	Delivered Lumens	Color Temp.	Base Color
BT-ALLY-19	99.95	8w	220° wide angle	10 - 800 Lumens	Adjustable White 2700K-5000K or RGBW Presets or Custom	White

Description: 120 Volt A19 RGBW CCT Lamp, bt System App-Controlled, 220 Degree Flood, 10 - 800 Lumens, 2700K - 4000K, White Base

MR8 LED



Part #	Price \$	Wattage	Delivered Lumens	Color Temp.	Beam Angle
LMR8-LED-4W-F	49.38	2W	150 Lumens	2900K	45° Flood

MR11 LED



Part #	Price \$	Wattage	Delivered Lumens	Color Temp.	Beam Angle
LMR11-LED-4W-F	38.59	4W	175 Lumens	2900K	45° Flood

MR16 LED



Part #	Price \$	Wattage	Beam Angle	Delivered Lumens	Color Temp.	Base Color
LMR16-LED-4W-NS	31.38	4w	Narrow Spot (15°)	250 Lumens	2900K	Black
*LMR16-LED-4W-F	31.38	4w	Flood (45°)	250 Lumens	2900K	Black
LMR16-LED-4W-WF	31.38	4w	Wide Flood (60°)	250 Lumens	2900K	Black
LMR16-LED-250lm	31.38	4w	Flood (45°)	250 Lumens	2900K	Black
LMR16-LED-4W-2700K	31.38	4w	Flood (45°)	250 Lumens	2700K	Black
LMR16-LED-5W-NS	31.38	5w	Narrow Spot (15°)	310 Lumens	2900K	White
*LMR16-LED-5W-F	31.38	5w	Flood (45°)	310 Lumens	2900K	White
LMR16-LED-5W-WF	31.38	5w	Wide Flood (60°)	310 Lumens	2900K	White
LMR16-LED-310lm	31.38	5w	Flood (45°)	310 Lumens	2900K	White
LMR16-LED-5W-2700K	31.38	5w	Flood (45°)	310 Lumens	2700K	White
*LMR16-LED-6W-F	38.59	6w	Flood (45°)	410 Lumens	2900K	Blue
LMR16-LED-6W-2700K	38.59	6w	Flood (45°)	410 Lumens	2700K	Blue

PAR36 LED

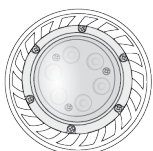

Part #	Price \$	Wattage	Beam Angle	Delivered Lumens	Color Temp.	Base Color
LPAR36-LED-4W-F	87.08	4w	Flood (20°)	250 Lumens	2800K	Gray
*LPAR36-LED-4W-WF	87.08	4w	Wide Flood (40°)	250 Lumens	2800K	Gray
LPAR36-LED-8W-F	103.27	8w	Flood (20°)	300 Lumens	2800K	Black
*LPAR36-LED-8W-WF	103.27	8w	Wide Flood (40°)	300 Lumens	2800K	Black
LPAR36-LED-10W-F	120.05	10w	Flood (30°)	400 Lumens	2800K	Blue
*LPAR36-LED-10W-WF	120.05	10w	Wide Flood (45°)	400 Lumens	2800K	Blue
LPAR36-LED750lm	120.05	10w	Flood (30°)	750 Lumens	2800K	Light Blue

G4 BIPIN LED

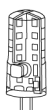

Part #	Price \$	Wattage	Beam Angle	Delivered Lumens	Color Temp.
*LBIPIN-LED-200lm	25.11	2.5w	Full (360°)	200 Lumens	2700K
LBIPIN-LED-250lm	25.11	3w	Full (360°)	250 Lumens	2700K
LBIPIN-LED-350lm	25.11	3.5w	Full (360°)	350 Lumens	2700K

LAMPS

3156 WEDGE LED



Part #	Price \$	Wattage	Beam Angle	Delivered Lumens	Color Temp.
L3156-LED-200lm	25.11	2.5w	Full (360°)	200 Lumens	2700K
L3156-LED-250lm	25.11	3w	Full (360°)	250 Lumens	2700K

T5 WEDGE LED

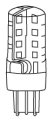

Part #	Price \$	Wattage	Beam Angle	Delivered Lumens	Color Temp.
L921T5-LED-200lm	25.11	2.5w	Full (360°)	200 Lumens	2700K

BAYONET LED

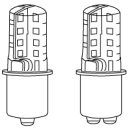

Part #	Price \$	Wattage	Beam Angle	Delivered Lumens	Color Temp.
LBA15S-LED-200lm (Single Contact)	25.11	2.5w	Full (360°)	200 Lumens	2700K
LBA15D-LED-200lm (Dual Contact)	25.11	2.5w	Full (360°)	200 Lumens	2700K

* = Standard lamp included when beam angle is not specified in part number.

Part #	Description	Category	Qty.
Literature			
MKT_CAT2025	2025 Product Catalog	Literature	20
MKT_AFP2025	2025 Accordion Fold Product Guide	Literature	25
MKT_PRO_CAT_2025	2025 Pro Series Catalog	Literature	10
MKT_LPG2025	2025 List Price Guide	Literature	10
MKT_HTG2024	2024 bt How-to Guide	Literature	10
MKT_ESP_BTHTG2024	2024 bt How-to Guide (Spanish)	Literature	10
MKT_IT2QSG	IT2 Quick Start Guide	Literature	N/A
MKT_ESP_IT2QSG	IT2 Quick Start Guide (Spanish)	Literature	10
MKT_BTALLY_RFG	bt ALLY Retrofit Guide	Literature	10
MKT_SEMBOOKLET	2024 bt Training Handbook for Seminars	Literature	10
MKT_IT2PRO-TBLGDE	IT PRO App Troubleshoot Guide	Literature	N/A
Flyers			
MKT_ALLYFYR	bt-ALLY Series Product Sales Sheet	Flyer	1
MKT_BLKFYR	Product Literature, Black Overcoat Fixture Product Sales Sheet	Flyer	1
MKT_HSCFYR	Product Literature, Heavy Sand-Cast Fixture Product Sales Sheet	Flyer	1
MKT_IT2FYR	Product Literature, it2 Transformer Product Sales Sheet	Flyer	1
MKT_ALLYFYR	Product Literature, bt-ALLY Series Product Sales Sheet	Flyer	1
MKT_GOLFFYR	Product Literature, GOL50-bt Product Sales Sheet	Flyer	1
MKT_PRO-CS	PRO Series Cut Sheet	Flyer	1
MKT_BTRE_FYR	BTRE Flyer	Flyer	1
MKT_DBL_FYR	Double Wire Lead Flyer	Flyer	1
MKT_MNT_FYR	Fixture Mounting Options Flyer	Flyer	1
MKT_HLOFYR	High Lumen Options Flyer	Flyer	1
MKT_HPFYR	English & Spanish Half-Page Flyer - Grow your business promo	Flyer	1
MKT_IT2FYR	IT2 Transformer Flyer	Flyer	1
MKT_DR_HNGR	Custom Door Hanger	Flyer	1
MKT_AOL_DR_HNGR	Door Hanger with Business Card Placeholder	Flyer	1
MKT_DYKREG_QR	Do You Know Registration QR Code	Flyer	1

*Items with "N/A" in "Qty." section are local print only. We do not ship those items.

MARKETING MATERIAL

Part #	Price \$	Description	Category	Qty.
Display Materials				
MKT_SIGN_BT_SYST		BT System Demo Aluminum Sign	Displays	1
MKT_SHOWBAG		Marketing Swag, 16" Width, 14" Height, Blue Tote Bag, Alliance Logo	Displays	1
MKT_CMAT_KIT		3 Counter Mats, 20" Width, 16" Height, Aged Brass Fixture Family, Black Overcoat Fixture Family, Power & Control	Displays	1
MKT_DIS-SF		Product Display Bracket, Single Fixture, Aluminum Construction, 1 Pre-drilled hole (Accepts 1/2" MPT thread), Slat Wall Insert	Displays	1
MKT_DIS-SW		Counter Top Product Display, Wood Laminate Construction, 24" Width, 4" Height, 8" Depth, 5 Pre-drilled Staggered Holes (Accepts 1/2" MPT thread), Includes Slat Wall Brackets	Displays	1
MKT_SWD-SIGN		Signage, 13" Width, 3.5" Height, Aluminum Sign, Blue, Alliance Logo for Slat Wall Displays	Displays	1
MKT_SIGN_AOL		Signage, 18" Width, 6" Height, Aluminum Sign, Blue, Alliance Logo	Displays	1
MKT_SIGN_AOL2		Signage, 24" Width, 12" Height, Aluminum Sign, Blue, Alliance Logo	Displays	1
MKT_SIGN_BLK		Signage, 24" Width, 12" Height, Aluminum Sign, Black Overcoat	Displays	1
MKT_BNR_AOL		Signage, 5' Width, 3' Height, Vinyl Grommeted Banner, Blue, Alliance Logo	Displays	1
MKT_DECAL		Outdoor Vehicle Decal, UV-Resistant, Blue, Alliance Logo	Displays	1
MKT_TBL_SKRT		Table Skirt, for 6' Tables, Blue, Alliance Logo	Displays	1
MKT_IT2_PU_BANNER		Signage, Retractable Pull Up Banner, 33" Width, 79" Height, it2 Transformer Promotion	Displays	1
MKT_FLR_STKR_ARROW		ALLIANCE Arrow Floor Sticker	Displays	1
Miscellaneous				
MKT_SEM_CERT		Seminar Certificate	Miscellaneous	N/A
MKT_REG_CARD		Seminar Participation Card	Miscellaneous	N/A

*Items with "N/A" in "Qty." section are local print only. We do not ship those items.

Alliance Outdoor Lighting warrants its products against defects in material and workmanship. Without charge, Alliance Outdoor Lighting will either repair or replace (Alliance Outdoor Lighting reserves the right to decide between repair or replacement) any properly installed Alliance Outdoor Lighting product that fails under normal operating conditions within the specified warranty period. Damage due to acts of nature, such as, but not limited to, lightning, flooding, explosions and earthquakes, are not covered.

PRODUCT WARRANTY DETAILS

BRASS, COPPER & BRONZE FIXTURES:

All have a lifetime warranty for all castings and housings.

IT2 SERIES TRANSFORMERS:

All IT2 series transformers carry a lifetime warranty on enclosures. All transformer windings carry a lifetime warranty.

XF SERIES TRANSFORMERS:

All XF series transformers carry a lifetime warranty on enclosures. All transformer windings carry a lifetime warranty.

TF SERIES TRANSFORMERS:

2 year warranty.

BT AND INTEGRATED LED FIXTURES

All Alliance LED integrated fixtures carry a 10 year warranty.

BT AND LED LAMPS:

10 year warranty.

ITIMERPRO:

10 year warranty.

TIMERS AND PHOTOCELLS:

Do not carry a warranty.

All products are warranted from the date of invoice, provided it is returned to the Alliance Outdoor Lighting distributor from where it is purchased. Our factory inspection determines it to be defective under the terms of the warranty. This warranty covers only equipment manufactured by Alliance Outdoor Lighting and does not extend to transportation, installation, labor compensation, or replacement charges, nor does it apply to any equipment of another manufacturer used in conjunction with Alliance Outdoor Lighting equipment.

NOTE: All Alliance Outdoor Lighting products are designed to be repaired in the field by a qualified lighting installer. All service parts are readily available and we encourage field repairs as a significant cost and labor savings which can be realized by the installer. All warranted components, as stated in the above warranty, which are installed in the field, will be honored.



ALLIANCE

OUTDOOR LIGHTING

